

ARISTA

Quick Start Guide

**7000 Series 2 RU
Data Center Switches**

Arista Networks

www.arista.com

PDOC-00039-15

Headquarters	Support	Sales
5453 Great America Parkway Santa Clara, CA 95054 USA		
+1 408 547-5500	+1 408 547-5502 +1 866 476-0000	+1 408 547-5501 + 1866 497-0000
www.arista.com	support@arista.com	sales@arista.com

© Copyright 2022 Arista Networks, Inc. The information contained herein is subject to change without notice. Arista Networks and the Arista logo are trademarks of Arista Networks, Inc in the United States and other countries. Other product or service names may be trademarks or service marks of others.

Contents

Chapter 1: Overview.....	1
1.1 Scope.....	1
1.2 Receiving and Inspecting the Equipment.....	1
1.3 Installation Process.....	1
1.4 Safety Information.....	2
1.5 Obtaining Technical Assistance.....	2
1.6 Specifications.....	3
Chapter 2: Preparation.....	7
2.1 Site Selection.....	7
2.2 Reconfiguring Air Flow.....	9
2.3 Tools and Parts Required for Installation.....	9
2.4 Electrostatic Discharge (ESD) Precautions.....	10
Chapter 3: Rack Mounting the Switch.....	11
3.1 Two-Post Rack Mount.....	11
3.1.1 Attaching Mounting Brackets to the Chassis.....	12
3.1.2 Inserting the Switch into the Rack.....	12
3.2 Four-Post Rack Mount.....	13
3.2.1 Extracting the Brackets and the Rails.....	14
3.2.2 Attaching Mounting Brackets to the Chassis.....	15
3.2.3 Expanding the Rails.....	16
3.2.4 Assembling the Rails onto the Equipment Rack.....	17
3.2.5 Attaching the Switch to the Rack.....	17
Chapter 4: Cabling the Switch.....	19
4.1 Grounding the Switch.....	19
4.1.1 Models with Grounding Pads.....	19
4.1.2 Models without Grounding Pads.....	19
4.1.3 Grounding Adapter Assembly.....	20
4.2 Connecting Power Cables.....	21
4.2.1 AC Power Supplies.....	21
4.2.2 DC Power Supplies.....	22
4.3 Connecting Serial and Management Cables.....	24
Chapter 5: Configuring the Switch.....	27
Appendix A: Status Indicators.....	29
A.1 Front Indicators.....	29
A.1.1 Switch Indicators.....	29
A.1.2 Port Indicators.....	30
A.2 Rear Status Indicators.....	31

Appendix B: Parts List.....	33
B.1 Rack Mount Parts.....	33
B.1.1 Four-Post Rack Mount Parts.....	33
B.1.2 Two-Post Rack Mount Parts.....	33
B.2 Cables.....	34
Appendix C: Front Panel.....	35
C.1 Port-Speed Groups.....	35
C.2 Front Panels.....	35
Appendix D: Rear Panel.....	45
Appendix E: Regulatory Model Numbers.....	47
Appendix F: Taiwan RoHS Information.....	49

Overview

This guide is intended for properly trained service personnel and technicians who need to install selected Arista Networks Data Center Switches.

The following topics are covered in this section:

- [Scope](#)
- [Receiving and Inspecting the Equipment](#)
- [Installation Process](#)
- [Safety Information](#)
- [Obtaining Technical Assistance](#)
- [Specifications](#)

1.1 Scope

The following Arista Networks Data Center Switches are supported by this guide:

DCS-7050SX-128	DCS-7250QX-64	DCS-7280QR-C72	DCS-7280CR3-96
DCS-7050TX-128	DCS-7260QX-64	DCS-7280CR-48	DCS-7280CR3K-96
DCS-7050SX2-128	DCS-7260CX-64	DCS-7280CR2-60	DCS-7050SX3-96YC8
DCS-7050TX2-128	DCS-7260CX3-64	DCS-7280CR2A-60	
DCS-7170-64C	DCS-7260CX3-64E	DCS-7280CR2K-60	

 **Important:** Only qualified personnel should install, service, or replace this equipment.

Seul le personnel qualifié doit installer, service, ou remplacer cet équipement.

1.2 Receiving and Inspecting the Equipment

Upon receiving the switch, inspect the shipping boxes and record any external damage. Retain packing materials if you suspect that part of the shipment is damaged; the carrier may need to inspect them.

If the boxes were not damaged in transit, unpack them carefully. Ensure that you do not discard any accessories that may be packaged in the same box as the main unit.

Inspect the packing list and confirm that you received all listed items. Compare the packing list with your purchase order. [Parts List](#) provides a list of components included with the switch.

1.3 Installation Process

The following tasks are required to install and use the switch:

1. Select and prepare the installation site ([Site Selection](#)).
2. Assemble the installation tools listed ([Tools and Parts Required for Installation](#)).

3. Attach the mounting brackets and install the switch in an equipment rack ([Rack Mounting the Switch](#)).
4. Connect the switch to the power source and network devices ([Cabling the Switch](#)).
5. Configure the switch ([Configuring the Switch](#)).

 **Important:** Class 1 Laser Product: This product has provisions to install Class 1 laser transceivers which provide optical coupling to the communication network. Once a Class 1 laser product is installed, the equipment is a Class 1 Laser Product. The customer is responsible for selecting and installing the Class 1 laser transceiver and for insuring that the Class 1 AEL (Allowable Emission Limit) per EN/IEC 60825, CSA E60825-1, and Code of Federal Regulations 21 CFR 1040 is not exceeded after the laser transceiver have been installed. Do not install laser products whose class rating is greater than 1. Refer to all safety instructions that accompanied the transceiver prior to installation. Only Class 1 laser devices, certified for use in the country of installation by the cognizant agency are to be utilized in this product.

Appareil à laser de classe 1 Cet appareil comporte des dispositions permettant d'installer des émetteurs-récepteurs fournissant un couplage optique au réseau de communication. Une fois l'appareil à laser de classe 1 installé, l'équipement devient un appareil à laser de classe 1. Le client est responsable du choix et de l'installation de l'émetteur-récepteur à laser de classe 1 et il doit s'assurer que les limites d'émission admissibles pour la classe 1 régularisées par les normes EN/IEC 60825 et CAN/CSA E60825-1 et par le Code of Federal Regulations 21 CFR 1040 ne soient pas dépassées après l'installation de l'émetteur-récepteur à laser. N'installez pas d'appareils à laser dont la classification est supérieure à 1. Avant l'installation, lisez attentivement les instructions de sécurité fournies avec l'émetteur-récepteur. Seuls les appareils à laser de classe 1 qui ont été certifiés par l'autorité agréée pour une utilisation dans le pays d'installation peuvent être utilisés dans ce produit.

 **Important:** Ultimate disposal of this product should be in accordance with all applicable laws and regulations.

Élimination définitive de ce produit devrait être en conformité avec toutes les lois et règlements applicables.

1.4 Safety Information

Refer to the Arista Networks document *Safety Information and Translated Safety Warnings* available at: <https://www.arista.com/en/support/product-documentation>.

1.5 Obtaining Technical Assistance

Any customer, partner, reseller or distributor holding a valid Arista Service Contract can obtain technical support in any of the following ways:

- **Email:** support@arista.com. This is the easiest way to create a new service request. Include a detailed description of the problem and the output of “show tech-support”.
- **Web:** <https://www.arista.com/en/support>.

A support case may be created through the support portal on our website. You may also download the most current software and documentation, as well as view FAQs, Knowledge Base articles, Security Advisories, and Field Notices.

- **Phone:** +1 866-476-0000 or +1 408-547-5502.

! **Important:** No user serviceable parts inside. Refer all servicing to qualified service personnel.

Aucune pièce réparable par l'utilisateur à l'intérieur. Confiez toute réparation à un technicien qualifié.

1.6 Specifications

The following table lists the specifications of Arista Data Center switches covered by this guide.

Table 1: Switch Specifications (Dimensions and Weights)

Switch	Size (W x H x D)	Weight
DCS-7050SX-128	48.3 x 8.9 x 45.9 cm (19 x 3.5 x 18.1 inches)	15.1 kg (33 lbs.)
DCS-7050TX-128	48.3 x 8.9 x 45.9 cm (19 x 3.5 x 18.1 inches)	15.6 kg (34 lbs.)
DCS-7050SX2-128	48.3 x 8.9 x 45.9 cm (19 x 3.5 x 18.1 inches)	15.1 kg (33 lbs.)
DCS-7050TX2-128	48.3 x 8.9 x 45.9 cm (19 x 3.5 x 18.1 inches)	15.6 kg (34 lbs.)
DCS-7250QX-64	48.3 x 8.9 x 55.3 cm (19 x 3.5 x 21.8 inches)	19.2 kg (42 lbs.)
DCS-7260QX-64	48.3 x 8.9 x 45.7 cm (19 x 3.5 x 18.0 inches)	16.1 kg (35.5 lbs.)
DCS-7260CX-64	48.3 x 8.9 x 45.7 cm (19 x 3.5 x 18.0 inches)	21.3 kg (47 lbs.)
DCS-7260CX3-64	48.3 x 8.9 x 45.4 cm (19 x 3.5 x 17.9 inches)	15.6 kg (34 lbs.)
DCS-7260CX3-64E	48.3 x 8.9 x 45.4 cm (19 x 3.5 x 17.9 inches)	15.6 kg (34 lbs.)
DCS-7280CR-48	48.3 x 8.9 x 56.3 cm (19 x 3.5 x 22.2 inches)	21.2 kg (47 lbs.)
DCS-7280CR2-60	48.3 x 8.9 x 64.0 cm (19 x 3.5 x 25.2 inches)	24.9 kg (54.8 lbs.)
DCS-7280CR2A-60	48.3 x 8.9 x 64.0 cm (19 x 3.5 x 25.2 inches)	24.9 kg (54.8 lbs.)
DCS-7280CR2K-60	48.3 x 8.9 x 64.0 cm (19 x 3.5 x 25.2 inches)	24.9 kg (54.8 lbs.)
DCS-7170-64C	48.3 x 8.9 x 45.4 cm (19 x 3.5 x 17.9 inches)	15.9 kg (35 lbs.)
DCS-7280QR-C72	48.3 x 8.9 x 56.3 cm (19 x 3.5 x 22.2 inches)	21.5 kg (47.3 lbs.)
DCS-7280CR3-96	48.3 x 8.9 x 75.3 cm (19 x 3.5 x 30.0 inches)	23.6 kg (52.0 lbs.)
DCS-7280CR3K-96	48.3 x 8.9 x 75.3 cm (19 x 3.5 x 30.0 inches)	23.6 kg (52.0 lbs.)
DCS-7050SX3-96YC8	48.3 x 8.9 x 50.2 cm (19 x 3.5 x 19.8 inches)	19.5 kg (42.9 lbs.)

Table 2: Switch Specifications (Operational and Storage)

Switch	Operating Temperature	Storage Temperature	Operating Altitude	Relative Humidity
All	0° to 40°C (32° to 104°F)	-25° to 70°C (-13° to 158°F)	0 to 3,000 meters (0 to 10,000 feet)	5 to 90%

Table 3: Switch Specifications (Power Input)

Power Input (AC Power)	Switch/PSU	Ratings
------------------------	------------	---------

	DCS-7050SX-128 / PWR-500AC	100 - 240 VAC, 5.7-2.4 A, 50/60 Hz
	DCS-7050SX-128 / PWR-750AC	100 - 240 VAC, 5.7-2.4 A, 50/60 Hz
	DCS-7050TX-128 / PWR-745AC	100 - 240 VAC, 10-5 A, 50/60 Hz
	DCS-7050SX2-128 / PWR-500AC	100 - 240 VAC, 5.7-2.4 A, 50/60 Hz
	DCS-7050TX2-128 / PWR-745AC	100 - 240 VAC, 10-5 A, 50/60 Hz
	DCS-7250QX-64 / PWR-1100AC	200 - 240 VAC, 6.5 A, 50/60 Hz
	DCS-7260QX-64 / PWR-1100AC	200 - 240 VAC, 6.5 A, 50/60 Hz
	DCS-7260CX-64 / PWR-1900AC	200 - 240 VAC, 11.5 A, 50/60 Hz
	DCS-7260CX3-64 / PWR-745AC	100 - 240 VAC, 10-5 A, 50/60 Hz
	DCS-7260CX3-64E / PWR-745AC	100 - 240 VAC, 10-5 A, 50/60 Hz
	DCS-7280CR-48 / PWR-1900AC	200 - 240 VAC, 11.5 A, 50/60 Hz
	DCS-7280CR2-60 / PWR-1900AC	200 - 240 VAC, 11.5 A, 50/60 Hz
	DCS-7280CR2A-60 / PWR-1900AC	200 - 240 VAC, 11.5 A, 50/60 Hz
	DCS-7280CR2K-60 / PWR-1900AC	200 - 240 VAC, 11.5 A, 50/60 Hz
	DCS-7170-64C / PWR-745AC	100 - 240 VAC, 10-5 A, 50/60 Hz
	DCS-7280QR-C72 / PWR-1900AC	200 - 240 VAC, 11.5 A, 50/60 Hz
	DCS-7280CR3-96 / PWR-2411-AC	200 - 240 VAC, 14.0 A, 50/60 Hz
	DCS-7280CR3K-96 / PWR-2411-AC	200 - 240 VAC, 14.0 A, 50/60 Hz
	DCS-7050SX3-96YC8 / PWR-1011-AC	100 - 120 / 200 - 240 VAC, 12.0 / 6.0A, 50/60 Hz
Power Input (DC Power)	DCS-7050SX-128 / PWR-500DC	-48 to 60 VDC, 15 A
	DCS-7050TX-128 / PWR-1900DC	-48 to 60 VDC, 32 A

DCS-7250QX-64 / PWR-1900DC	-48 to 60 VDC, 32 A
DCS-7260CX-64 / PWR-1900DC	-48 to 60 VDC, 46 A
DCS-7260CX3-64 / PWR-1900DC	-48 to 60 VDC, 32 A
DCS-7260CX3-64E / PWR-1900DC	-48 to 60 VDC, 32 A
DCS-7280CR-48 / PWR-1900DC	-48 to 60 VDC, 52 A
DCS-7280CR2-60 / PWR-1900DC	-48 to 60 VDC, 52 A
DCS-7280CR2A-60 / PWR-1900DC	-48 to 60 VDC, 52 A
DCS-7280CR2K-60 / PWR-1900DC	-48 to 60 VDC, 52 A
DCS-7170-64C / PWR-1900DC	-48 to 60 VDC, 32 A
DCS-7280QR-C72 / PWR-1900DC	-48 to 60 VDC, 32 A
DCS-7280CR3-96 / PWR-2411-DC	-48 to 60 VDC, 72 A
DCS-7280CR3K-96 / PWR-2411-DC	-48 to 60 VDC, 72 A
DCS-7050SX3-96YC8 / PWR-1011-DC	-48 to 60 VDC, 30 A

Table 4: Switch Specifications (Power Draw)

Switch	Power Draw (Typical / Maximum)
DCS-7050SX-128	235 W / 415 W
DCS-7050TX-128	570 W / 740 W
DCS-7050SX2-128	220 W / 395 W
DCS-7050TX2-128	430 W / 580 W
DCS-7250QX-64	622 W / 946 W
DCS-7260QX-64	315 W / 850 W
DCS-7260CX-64	1672 W / 2090 W
DCS-7260CX3-64	314 W / 616 W
DCS-7260CX3-64E	314 W / 616 W
DCS-7280CR-48	1363 W / 1710 W
DCS-7280CR2-60	1660 W / 1850 W

DCS-7280CR2A-60	1760 W / 1950 W
DCS-7280CR2K-60	1760 W / 1950 W
DCS-7170-64C	335 W / 585 W
DCS-7280QR-C72	696 W / 1200 W
DCS-7280CR3-96	1100 W / 1800 W
DCS-7280CR3K-96	1100 W / 1800 W
DCS-7050SX3-96YC8	218 W / 453 W

Preparation

The following topics are covered in this section:

- [Site Selection](#)
- [Tools and Parts Required for Installation](#)
- [Electrostatic Discharge \(ESD\) Precautions](#)

2.1 Site Selection

The following criteria should be considered when selecting a site to install the switch:

- **Temperature and Ventilation:** For proper ventilation, install the switch where there is ample airflow to the front and back of the switch. The ambient temperature should not go below 0° or exceed 40°C.
 - ⚠ **Important:** To prevent the switch from overheating, do not operate it in an area where the ambient temperature exceeds 40°C (104°F).
Pour empêcher l'interrupteur de surchauffe, ne pas utiliser il dans une zone où la température ambiante est supérieure à 40°C (104°F).
- **Airflow Orientation:** The fans and PSUs determine the airflow direction through the switch. The color of the visible handles or labels indicate the airflow direction.
 - 📄 **Note:** The figures shown use representative Arista switches to illustrate airflow directions. For some switches, label color indicates the airflow direction.
- **Blue Handle:** Air Inlet module. The following figure shows the airflow through the switch with air inlet modules:

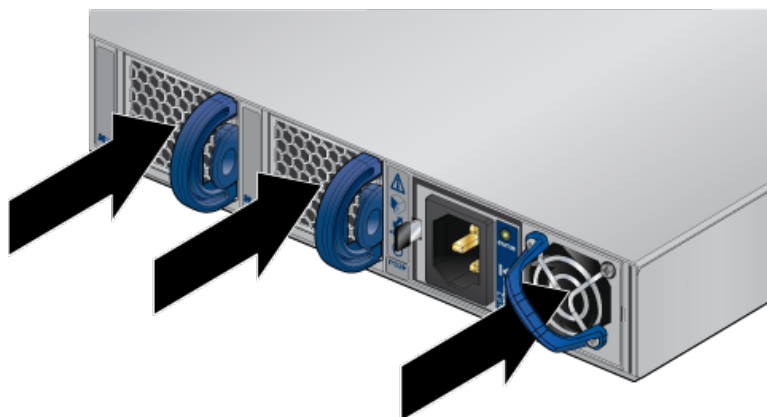
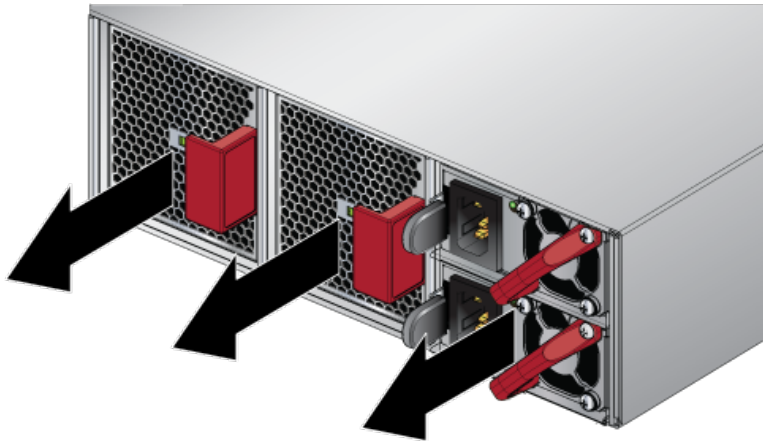

Figure 1: Air Inlet Module

- **Red Handle:** Air Exit module. The following figure shows the airflow through the switch with air exit modules:

Figure 2: Air Exit Module



Orient the switch such that the airflow through the switch is from the cooler to the hotter aisle. If the airflow direction is not compatible with the installation site, reorient the fan modules to circulate air in the opposite direction.

- **Rack Space:** Install the switch in a 19" rack or cabinet. The switch height is 2 RU. The accessory kit provides mounting brackets for four-post racks. Contact your sales representative to obtain two-post mounting brackets.

When mounting the switch in a partially filled rack, load the rack from bottom to top, with the heaviest equipment at the bottom. Load the switch at the bottom if it is the only item in the rack.

- **Power Requirements:** Power requirements vary by switch and power supply model. Refer to [Table 3: Switch Specifications \(Power Input\)](#) for information regarding your specific system.

Two circuits provide redundancy protection. [Grounding the Switch](#) describes power cable requirements.

- ⚠ **Important:** The power input plug-socket combination must be accessible at all times; it provides the primary method of disconnecting power from the system.

La combinaison de la puissance-prise d'entrée doit être accessible en tout temps ; Il fournit le principal moyen de coupure d'alimentation du système.

- **Other Requirements:** Select a site where liquids or objects cannot fall onto the equipment and foreign objects are not drawn into the ventilation holes. Verify these guidelines are met:

- Clearance areas to the front and rear panels allow for unrestricted cabling.
- All front and rear panel indicators can be easily read.
- Power cords can reach from the power outlet to the connector on the rear panel.

- ⚠ **Important:** All power connections must be removed to de-energize the unit.

Toutes les connexions d'alimentation doivent être enlevées pour hors tension l'appareil.

- ⚠ **Important:** This unit is intended for installation in restricted access areas.

Cet appareil est prévu pour une installation dans les zones d'accès restreintes.

2.2 Reconfiguring Air Flow

Some switches allow configuration with either front-to-rear or rear-to-front airflow. To reconfigure a system, de-energize the unit and replace all fans and power supplies with the desired orientation. Mixing front-to-rear and rear-to-front components is not supported and will impact the cooling capacity of the switch.

DCS-7260CX3 and DCS-7170-64 systems contain additional louvers behind the fan tray. These louvers follow the same color coding as the fans and must be removed, rotated and replaced when changing airflow orientation.

The following figures show the location of the louvers.

 **Note:** All PSUs and fans must be of the same airflow orientation in a switch.

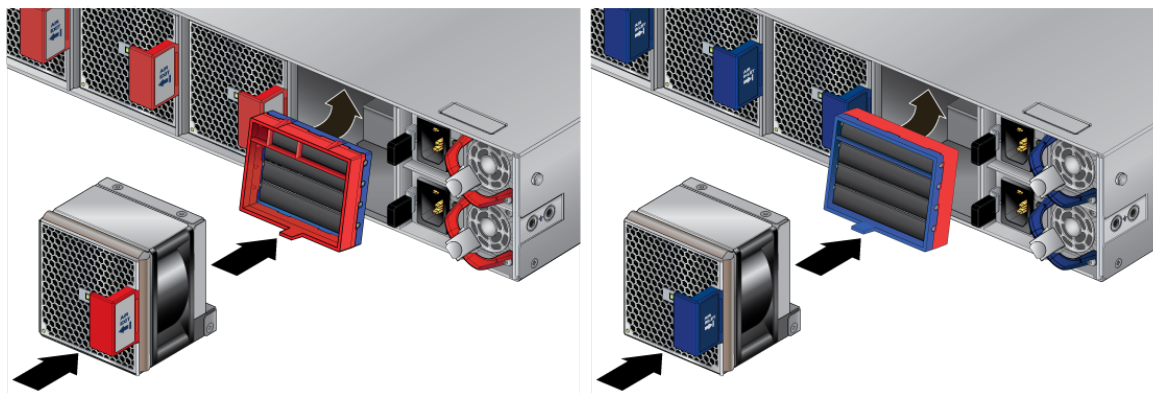

To replace the lover behind the fan:

1. Lift the tab up.
2. Rotate and remove the louver.
3. Rotate the louver so the desired color is on the outside.
4. Slide and seat the louver until it clicks into place.

2.3 Tools and Parts Required for Installation

The following tools and equipment are required to install the switch:

Two-Post Rack

- Screws or rack mounting nuts and bolts.
- Screwdriver

Four-Post Rack (Toolless)

No additional equipment required.

Accessory kit does not include screws for attaching the switch to the equipment rack. When installing the switch into an equipment rack with unthreaded post holes, nuts are also required to secure the switch to the rack posts.

2.4 Electrostatic Discharge (ESD) Precautions

Observe these guidelines to avoid ESD damage when installing or servicing the switch.

- Assemble or disassemble equipment only in a static-free work area.
- Use a conductive work surface (such as an anti-static mat) to dissipate static charge.
- Wear a conductive wrist strap to dissipate static charge accumulation.
- Minimize handling of assemblies and components.
- Keep replacement parts in their original static-free packaging.
- Remove all plastic, foam, vinyl, paper, and other static-generating materials from the work area.
- Use tools that do not create ESD.

Rack Mounting the Switch

The following topics are covered in this section:

- [Two-Post Rack Mount](#)
- [Four-Post Rack Mount](#)

 **Important:** The rack mounting procedure is identical for all switches covered by this guide. Illustrations in this chapter depict the mounting of a DCS-7050SX-128 switch.

Les procédures de montage du bâti est identique pour tous les commutateurs visés par ce guide. Illustrations dans ce chapitre montrent le montage d'un interrupteur de DCS-7050SX-128.

After completing the instructions for your rack type, proceed to [Cabling the Switch](#).

3.1 Two-Post Rack Mount

To mount the switch onto a two-post rack, assemble the mounting brackets to the chassis, then attach the brackets to the rack posts. Two-post accessory kits includes 2 three-hole mounting brackets.

Each chassis side has attachment pins that align with bracket holes; the number of pins (six or seven) varies by switch model. Pin orientation is symmetric and equidistant, supporting bracket placement where the flange is either flush with the front and rear panels, or not flush with the panels. Each bracket hole includes a key-opening for placing the bracket flush with the chassis and then locking it into place.

 **Important:** Attachment pins must engage all three upper bracket holes.

Goupilles de fixation doivent s'engager tous les trois trous de la bride supérieure.

Bracket Mount Examples for Two-Post Rack Mount displays proper bracket mount configuration examples. Improper Bracket Mount Examples for Two-Post Rack Mount displays improper bracket mount configuration examples.

Figure 3: Bracket Mount Examples for Two-Post Rack Mount

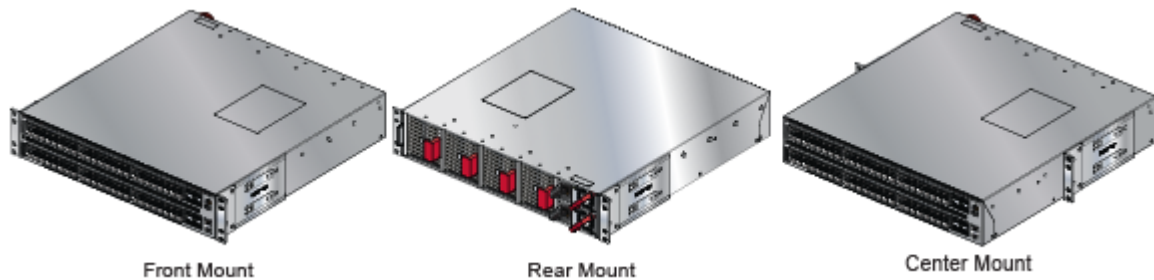
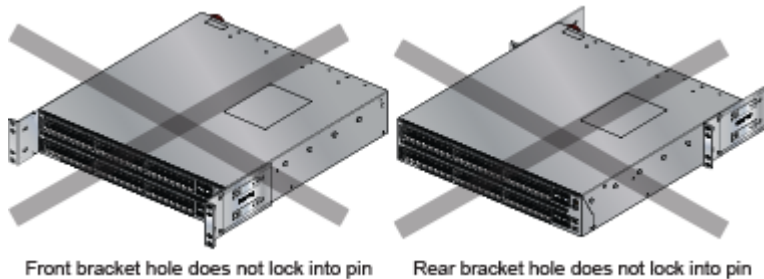

Figure 4: Improper Bracket Mount Examples for Two-Post Rack Mount



3.1.1 Attaching Mounting Brackets to the Chassis

This procedure attaches mounting brackets to the switch chassis

1. Align the mounting brackets with the attachment pins to obtain the desired mounting position.
2. Place the bracket flush on the chassis with attachment pins protruding through key-openings.
3. Slide the bracket toward the front flange until the bracket clip locks with an audible click.

Figure 5: Attaching the Mounting Brackets to the Switch Chassis

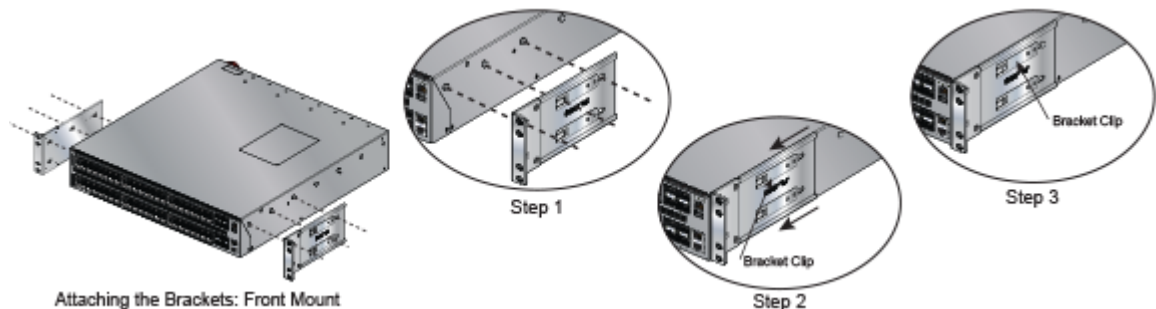

To remove the mounting bracket from the chassis, lift the front edge of the mounting bracket clip with a flathead screwdriver and slide the bracket away from the front flange (opposite from the installation direction).

3.1.2 Inserting the Switch into the Rack

This procedure attaches the switch to the rack.

1. Lift the chassis into the rack. Position the flanges against the rack posts.

Figure 6: Inserting the Switch into the Rack

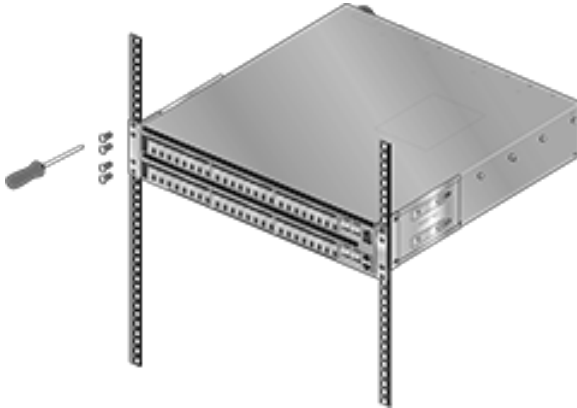

2. Select mounting screws that fit your equipment rack.
3. Attach the bracket flanges to the rack posts.

After completing the two-post rack mount, proceed to [Cabling the Switch](#).

3.2 Four-Post Rack Mount

The switch is mounted onto a four-post rack by assembling two rails onto the rear posts, sliding the switch onto the rails, then securing the switch to the front posts.

The installation kit provides two bracket-rail assemblies. The following four-post mounting parts are extracted from each assembly:

- Six-hole mounting bracket
- Rail

Each chassis side has attachment pins that align with bracket holes; the number of pins (six or seven) varies by switch model. Pin orientation is symmetric and equidistant, supporting bracket placement where the flange is either flush with the front and rear panels, or not flush with the panels. Each bracket hole includes a key-opening for placing the bracket flush with the chassis and then locking it into place.

! **Important:** Attachment pins must engage all six bracket holes.

Goupilles de fixation doivent s'engager tous les trous de support six.

[Figure 7: Bracket Mount Examples for Four-Post Rack Mount](#) displays proper bracket mount configuration examples. [Figure 8: Improper Bracket Mount Example for Four-Post Rack Mount](#) displays an improper bracket mount configuration examples.

Figure 7: Bracket Mount Examples for Four-Post Rack Mount

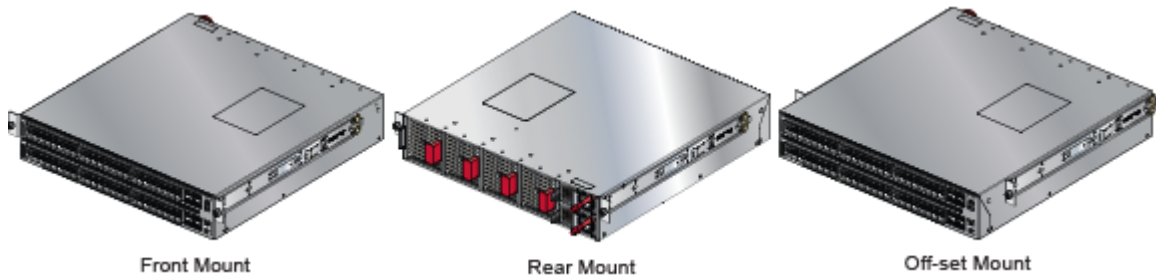
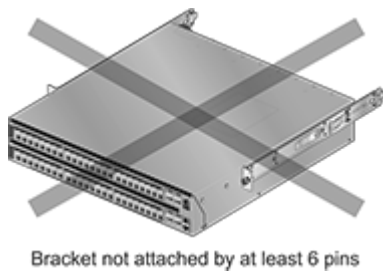

Figure 8: Improper Bracket Mount Example for Four-Post Rack Mount



Off-set mount is always an improper bracket mount configuration on switches that have six attachment pins on each side.

3.2.1 Extracting the Brackets and the Rails

[Figure 9: Bracket-Rail Assembly – Before and After Extraction](#) displays a bracket-rail assembly and the component pieces (bracket and rail) that are extracted from the assembly. Each assembly must be separated into its component pieces before mounting the switch into a four-post rack. The two assemblies supplied with the switch are identical.

Figure 9: Bracket-Rail Assembly – Before and After Extraction

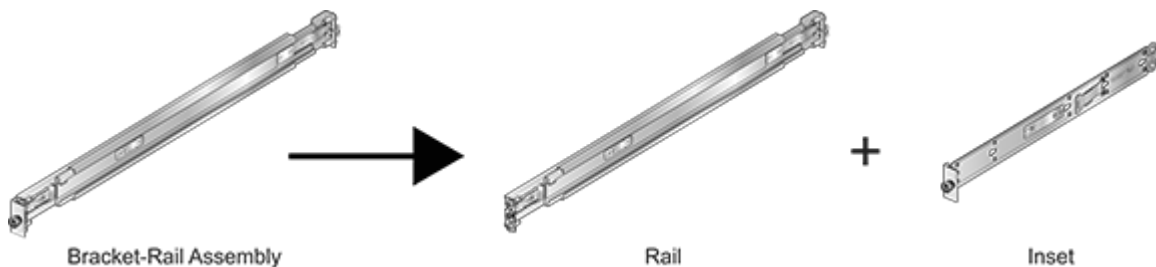

This procedure separates a bracket-rail assembly into its component pieces.

1. Grip the rail with your right hand, as shown in [Extracting the Bracket Rail Assembly-Left](#). Pull the bracket flange away from the rail flange with your left hand until the bracket clip catches on the rail ([Extracting the Bracket Rail Assembly-Right](#)).

If the bracket flange resists initially, verify the thumb screw on the bracket flange is not attached to the rail flange.

Figure 10: Extracting the Bracket-Rail Assembly

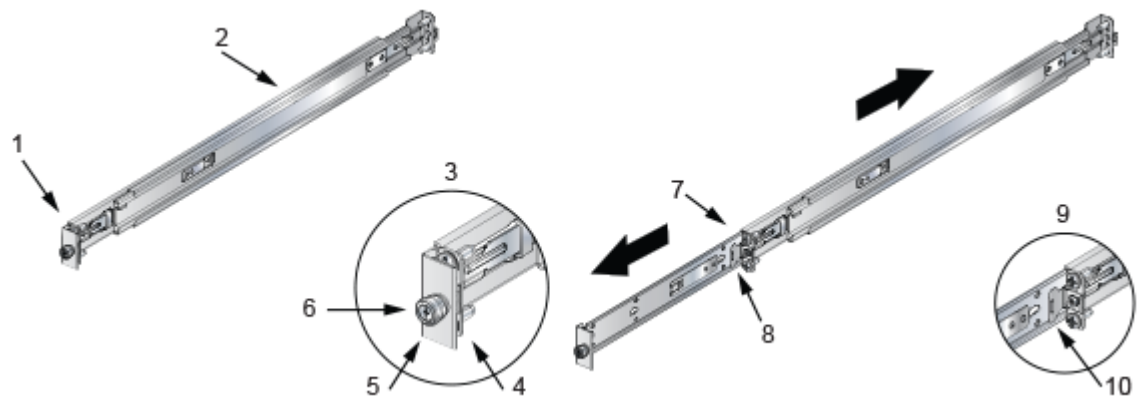

- | | | |
|--------------------|------------------|--------------------|
| 1 Inset A | 5 Bracket flange | 9 Inset B (detail) |
| 2 Rail (Grip here) | 6 Thumb screw | 10 Locking clip |
| 3 Inset A (detail) | 7 Inset B | |
| 4 Rail flange | 8 Locking clip | |

2. While pressing the locking clip on the bracket ([Extracting the Bracket Rail Assembly-Right](#)), resume pulling the bracket from the rail until the separation is complete.
3. Repeat the procedure for the other assembly.

3.2.2 Attaching Mounting Brackets to the Chassis

The [Figure 11: Front Bracket Alignment](#) displays the front bracket alignment for mounting the switch into a four-post rack.

This procedure attaches mounting brackets to the switch chassis as depicted by [Figure 12: Attaching the Mounting Brackets to the Switch Chassis](#).

1. Align the mounting brackets with the attachment pins to obtain the desired mounting position.
2. Place the bracket flush on the chassis with attachment pins protruding through key-openings.
3. Slide the bracket toward the front flange until the bracket clip locks with an audible click.

Figure 11: Front Bracket Alignment

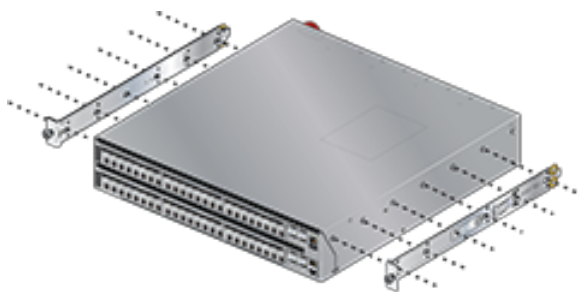

Attaching the Brackets: Front Mount

To remove the mounting bracket from the chassis, lift the front edge of the mounting bracket clip with a flathead screwdriver and slide the bracket away from the front flange (opposite from the installation direction).

Figure 12: Attaching the Mounting Brackets to the Switch Chassis

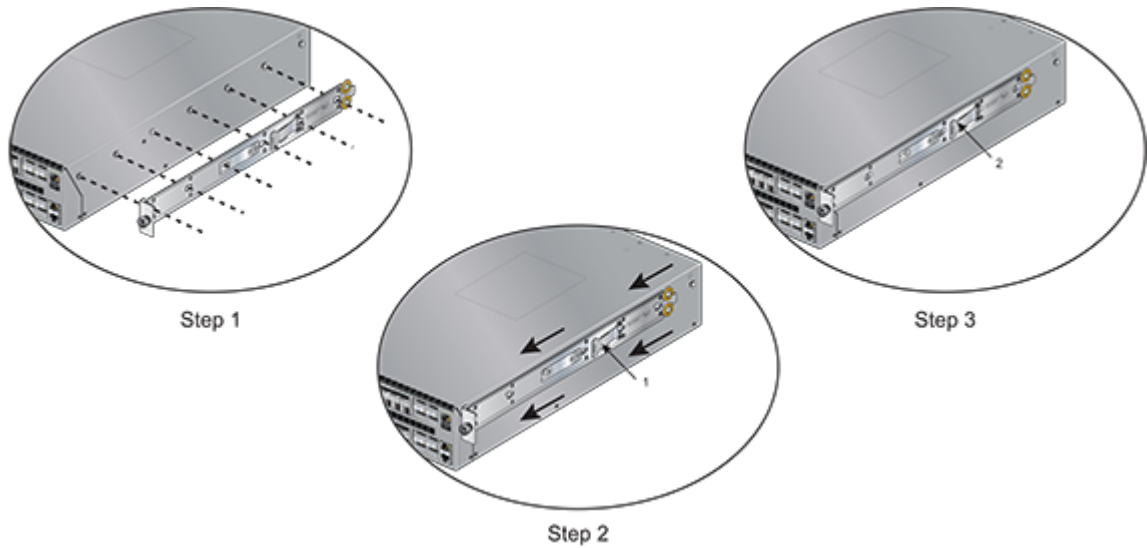

- 1 Bracket Clip
- 2 Bracket Clip

3.2.3 Expanding the Rails

The rail is a two-piece mechanism. The rail length is adjusted by sliding the rail-rod inside the rail-slide. The rail clip prevent extension of the rail beyond the maximum supported distance between front and rear rack posts. When the rail is contracted, the rail clip is closest to the slide end.

The rail is initially contracted and must be expanded to attach onto the rack. This procedure expands the rails from their contracted state:

1. Grip the slide end with your left hand and the rod end with your right hand ([Expanding the Rails-Left](#)).
2. Pull the ends apart until the rail-clip makes an audible click ([Expanding the Rails-Right](#)).

Figure 13: Expanding the Rails

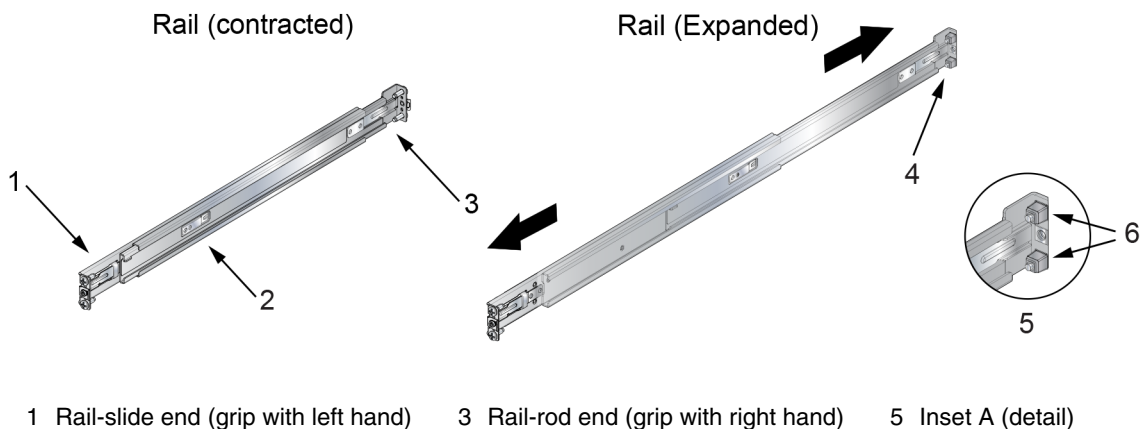

- 1 Rail-slide end (grip with left hand)
- 3 Rail-rod end (grip with right hand)
- 5 Inset A (detail)

2 Rail clip

4 Inset A

6 Rack plugs

3.2.4 Assembling the Rails onto the Equipment Rack

A rail connects a front post to a rear post. Each end has two rack plugs ([Attaching the Rails, Left-Inset A](#)[Expanding the Rails - Right, Inset A](#)). Rails are installed into a rack by inserting the plugs into rack slots. To install rails into posts with threaded or rounded holes, remove all plugs on both sides of the rails, then install the rails with bolts that fit the rack. This procedure attaches the rails to a four-post rack:

1. Attach rail to the right rear rack post by inserting rod-end rack plugs into post slots ([Attaching the Rails - Right, Inset A](#)). The slide assembly must be inside the right posts, relative to the left rack posts.

If the rack plugs were previously removed, use bolts to attach the rail to the rack.

2. Attach the slide end of the rail to the front post by extending the rail end past the post, then contracting the rail while guiding the rack plugs into the post ([Attaching the Rails - Inset B](#)).
3. Repeat Step 1 through Step 2 for the left posts. Ensure the rails are on the same horizontal level.

Figure 14: Attaching the Rails



1 Inset A

3 Inset B

2 Inset A (detail)

4 Inset B (detail)

3.2.5 Attaching the Switch to the Rack

After the rails are installed, the switch slides on the rails into the rack. Each bracket includes a thumb screw that attaches the switch to the rail.

1. Lift the switch into the rack and insert the mounting brackets into the slide rails.

2. Slide the switch on the rails, toward the rear posts, until the mounting bracket flanges are flush with the rail flanges attached to the rack posts.

Figure 15: Inserting the Switch onto the Rails

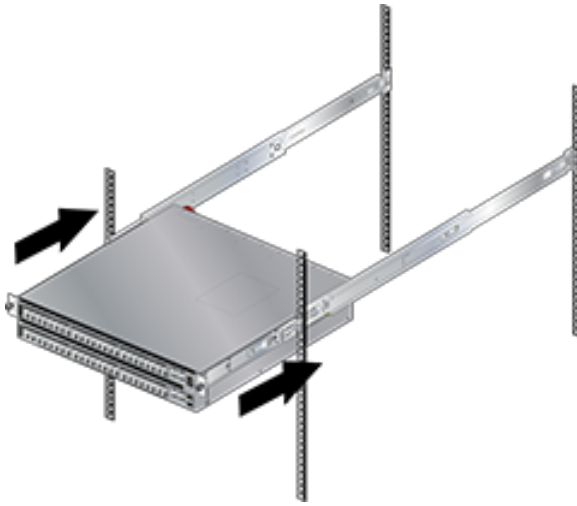

3. Attach the bracket flanges to the rack post using the quick-release thumb screws supplied with the brackets.

Figure 16: Attaching the Switch to the Rack Posts

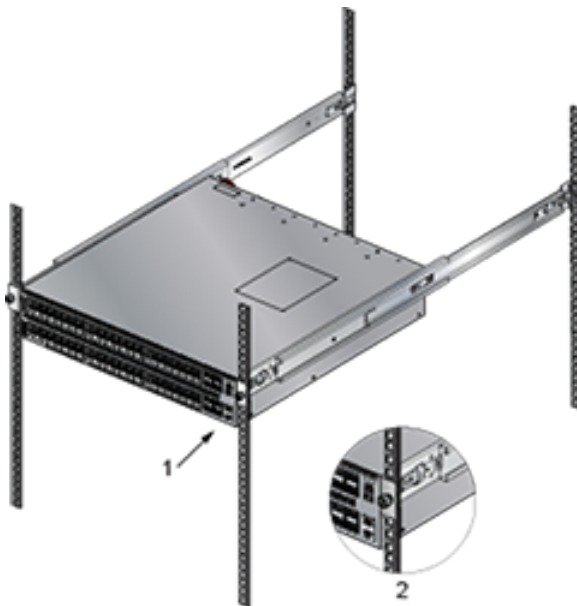

1 Inset A

2 Inset A (detail)

After completing the four-post rack mount, proceed to [Cabling the Switch](#).

Cabling the Switch

- [Grounding the Switch](#)
- [Connecting Power Cables](#)
- [Connecting Serial and Management Cables](#)

4.1 Grounding the Switch

After mounting the switch into the rack, connect the switch to the data center ground.

- !** **Important:** Grounding wires and grounding lugs (M4 x 0.7) are not supplied. Wire size should meet local and national installation requirements. Commercially available 6 AWG wire is recommended for installations in the U.S.

À la terre et de mise à la terre fils cosses (M4 x 0.7) ne sont pas fournis. Calibre des fils doit satisfaire des exigences de l'installation locale et nationale. Disponible dans le commerce 6 fils AWG est recommandé pour les installations aux États-Unis.

4.1.1 Models with Grounding Pads

Use the grounding pads ([Figure 17: Earth Grounding for Models with Ground Attach Point](#)) to attach the grounding lug before connecting to the data center ground.

Figure 17: Earth Grounding for Models with Ground Attach Point

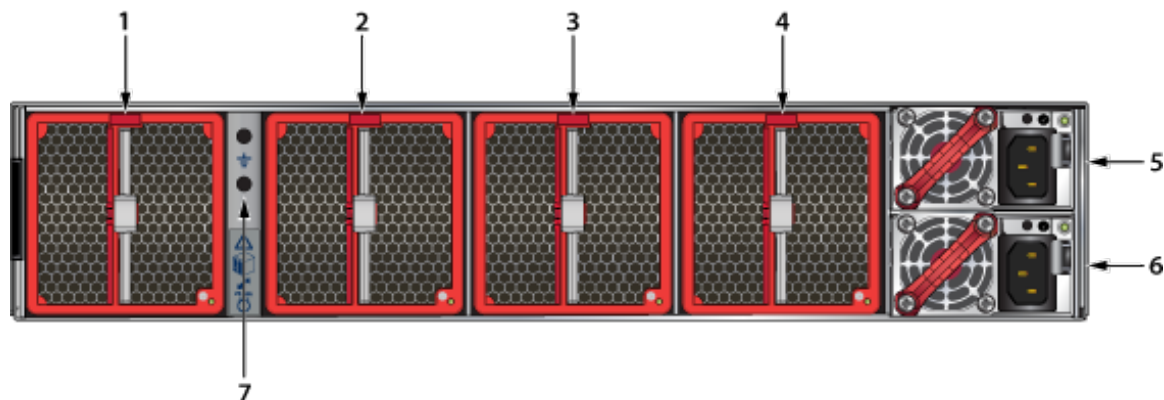

- | | | |
|----------------|-------------------------|-------------|
| 1 Fan Module 1 | 4 Fan Module 4 | 7 Grounding |
| 2 Fan Module 2 | 5 Power Supply Module 1 | |
| 3 Fan Module 3 | 6 Power Supply Module 2 | |

4.1.2 Models without Grounding Pads

For models that do not have grounding pads, use an adapter as shown for the DCS-7050SX3-96YC8 ([Figure 18: Earth Grounding Adapter for Models such as DCS-7050SX3-96YC8](#)). Assemble an adapter to attach to the chassis ([Grounding Adapter Assembly](#)). Attach the grounding lug to the adapter, once it is attached to the chassis.

 **Note:** A representative 1 RU chassis is used for the illustrations to highlight the grounding adapter assembly and attachment.

Figure 18: Earth Grounding Adapter for Models such as DCS-7050SX3-96YC8



4.1.3 Grounding Adapter Assembly

Use the following steps to assemble and attach a grounding assembly to the chassis before mounting it into the rack for models that require the grounding adapter. [Figure 19: Earth Grounding Adapter Assembly for Models such as DCS-7050SX3-96YC8](#) shows the exploded and assembled views.

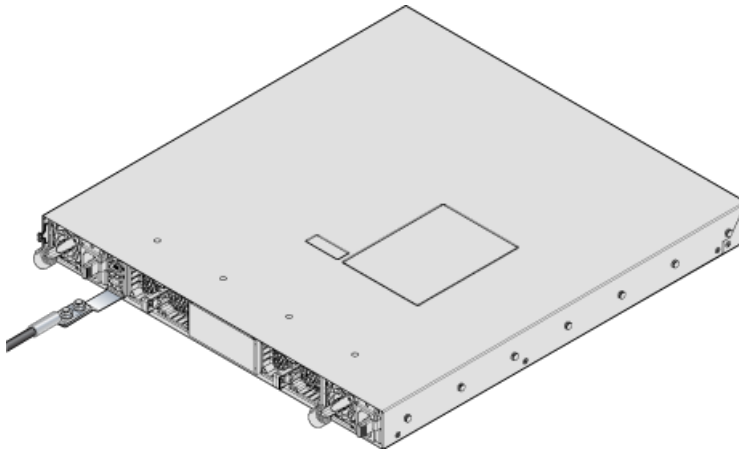
Figure 19: Earth Grounding Adapter Assembly for Models such as DCS-7050SX3-96YC8

 **Note:** The chassis is shown upside down in the following figure.

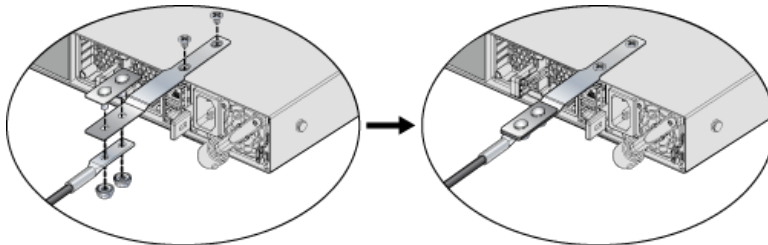

1. Identify all the components to be assembled:
 - 1x Grounding adapter
 - 1x Grounding bracket
 - 2x Flat-head screws (Phillips, M4 x 5.00 long, stainless steel)
 - 2x Hex nuts (#10-32, Serrated Flange, stainless steel)
 - 1x Grounding lug (Copper, 2-hole, 6 AWG, straight barrel)
2. Insert the grounding adapter through the holes in the grounding bracket.
3. Insert the ground lug on to the grounding adapter studs and fasten using the hex nuts to form the grounding assembly.
4. With the chassis on its top on a flat surface, attach the grounding assembly to the chassis using the flat head screws.
5. Turn the chassis over before mounting it into a rack and connecting cables.

4.2 Connecting Power Cables

 **Important:** Installation of this equipment must comply with local and national electrical codes. If necessary, consult with the appropriate regulatory agencies and inspection authorities to ensure compliance.

Installation de cet équipement doit être conformes aux codes électriques locaux et nationaux. Si nécessaire, consulter les organismes de réglementation appropriés et des autorités de contrôle pour assurer la conformité.

The switch operates with two installed power supplies. At least one power supply must connect to a power source. Two circuits provide redundancy protection.

[Rear Panel](#) displays the location of the power supplies on the rear panel of the switch.

 **Important:** Read all installation instructions before connecting the system to the power source.

Lire toutes les instructions d'installation avant de brancher le système à la source d'alimentation.

- **Non-Redundant Configuration:** Connect power to either of the two power supplies.
- **Redundant Power Supply Configuration:** Connect power to both power supplies.
- **Power down the Switch:** Remove all power cords and wires from the power supplies.

 **Important:** This equipment must be grounded. Never defeat the ground conductor.

Cet équipement doit être mis à la terre. Ne jamais modifier le conducteur de terre.

 **Important:** This unit requires overcurrent protection.

Cet appareil requiert une protection contre les surintensités.

4.2.1 AC Power Supplies

([Figure 20: AC Power Supply](#)) shows a supported AC power supply. The following AC power supplies are supported.

 **Note:** Several PSUs support both forward and reverse airflow directions.

PWR-500AC

PWR-1900AC

PWR-2411-AC

PWR-1100AC

PWR-745AC

PWR-1011-AC

Power requirements vary by switch. Refer to [Table 3: Switch Specifications \(Power Input\)](#) for information regarding your system as devices are supported only by the specified power supplies. The AC power supply connects to a circuit that provides the required power.

Figure 20: AC Power Supply displays an AC power supply, including the power socket on the left side of the module.

Figure 20: AC Power Supply

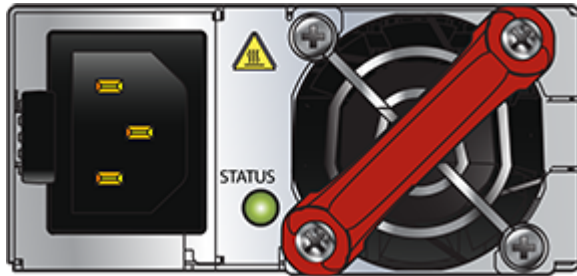

The accessory kit provides two IEC-320 power cables for the supported power supply for the device.

4.2.2 DC Power Supplies

The following power supplies are supported.

PWR-500DC

PWR-2411-DC

PWR-1900DC

PWR-1011-DC

Figure 21: Supported DC Power Supplies displays two supported DC power supplies.



Note: Several PSUs support both forward and reverse airflow directions.

Figure 21: Supported DC Power Supplies

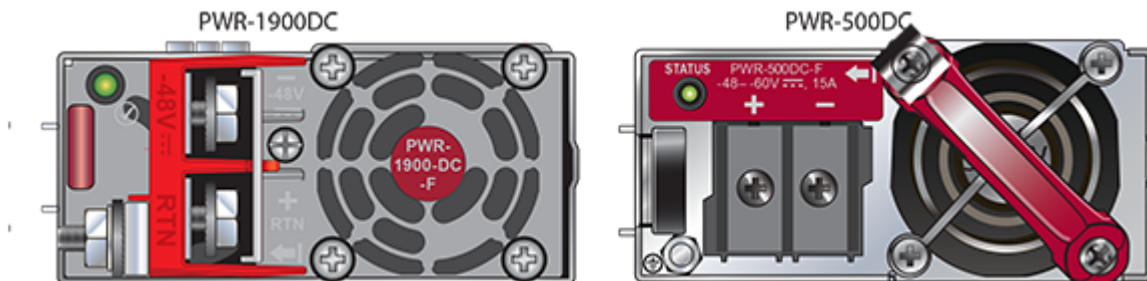

Important: A disconnect device must be provided as part of the installation.

Un dispositif de sectionnement doit être fourni dans le cadre de l'installation.



Important: Ensure power is removed from DC circuits before performing any installation actions. Locate the disconnect device, circuit breakers or fuses on DC power lines servicing the circuits. Turn off the power line circuits or remove the fuses.

Pouvoir assurer qu'il est retiré de circuits DC avant d'effectuer des actions d'installation .
Localiser les disjoncteurs ou des fusibles sur les lignes de courant continu desservant les circuits. Coupez les circuits de lignes d'alimentation ou retirer les fusibles.



Important: Wire size must comply with local and national requirements and electrical codes. Use only copper wire.

Le calibre du fil doit être conforme aux exigences locales et nationales et les codes électriques.
Utiliser du fil de cuivre.

- !** **Important:** Apply ground connection to the switch first during installation and remove last when removing power.

Appliquer connexion à la terre à l'interrupteur premier lors de l'installation et de supprimer la dernière alimentation lors du débranchement.

4.2.2.1 Wire and Lug Preparation

Before performing any installation actions, ensure power is removed from DC circuits by turning off the power line servicing the circuits. Prepare the stranded wiring before you begin a DC power installation.

- ☰** **Note:** Stranded copper wiring is required and should meet local and national installation requirements. Wires and grounding lugs are not supplied.

1. Attach an ESD grounding strap.
2. Prepare the stranded copper wiring for the power supply to be used. [Table 5: Wiring, Lug, and Tightening Torques for DC PSUs](#) provides wiring, lug, and tightening torque information for the power supplies covered in this guide.

Table 5: Wiring, Lug, and Tightening Torques for DC PSUs

PSU	Wire Size ⁽¹⁾		Lug Type ⁽²⁾	Tightening Torque	
	(AWG)	(mm ²)		N • m	in. • lbs.
PWR-500-DC	14 or larger	2.0 or larger	ring or spade/fork	1.0	9
PWR-1900-DC	4 - 6	21.2 - 13.3		2.7	24
PWR-1011-DC	6 - 8	16.0 - 10.0		2.7	24
PWR-2411-DC	2 - 4	35.0 - 25.0		2.7	24

1. Unless otherwise noted, wire size applies to -48V, Battery return, and Protective earth wires.

2. Unless otherwise noted, twin #10 studs spaced for dual-hole lug with 5/8" hole spacing.

3. Strip the wires to the appropriate length for the lugs to be used.
4. Use agency-approved compression (pressure) lugs for wiring terminations.
5. Slip on heat-shrink tubing on the wire ends before assembling the lugs on to the wire.

6. Crimp the lugs with the proper tool, and ensure that the tubing extends over the barrel of the lugs and the insulation on the wires ([Figure 22: Lug Preparation](#)).

Figure 22: Lug Preparation

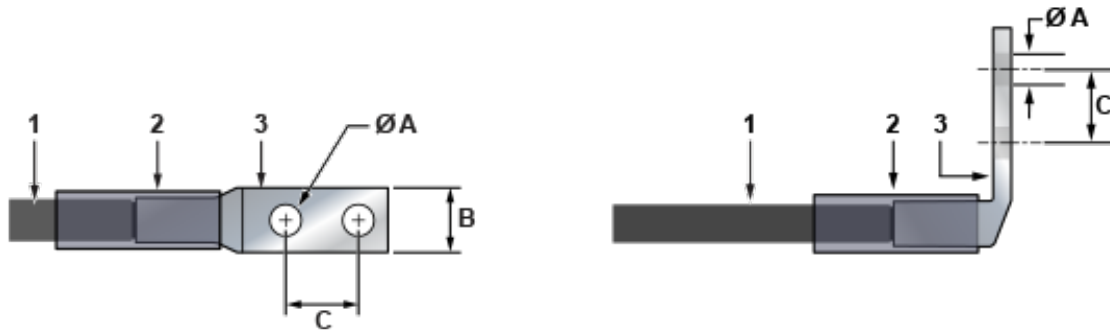

1 Insulated wire	3 Lug	B 1/2"
2 Heat-shrink tubing	A 1/4"	C 5/8"

 **Note:** Dimension B is the width of the lug (not visible on the right angle lug).

7. Shrink the tubing with a heat gun.

4.2.2.2 Connecting a DC Power Supply to Power Source

[Figure 23: DC PSU Connection Example](#) displays an example of connecting a PSU. To connect a DC power supply to a power source, perform the following:

1. Prepare the stranded wiring ([Wire and Lug Preparation](#)).
2. Attach the appropriate lugs to the source DC wires.
3. Connect the DC-input wires to the appropriate terminals using the specified torque ([Table 5: Wiring, Lug, and Tightening Torques for DC PSUs](#)) in the following order.

 **Note:** Remove terminal covers as needed.

- a. Ground wire to the Protective Earth (PE) terminal.
 - b. Negative source DC cable to the negative (- / -48V) terminal.
 - c. Positive (+) source DC cable to the positive (+ / Rtn) terminal.
4. Replace the terminal covers as required.

Figure 23: DC PSU Connection Example

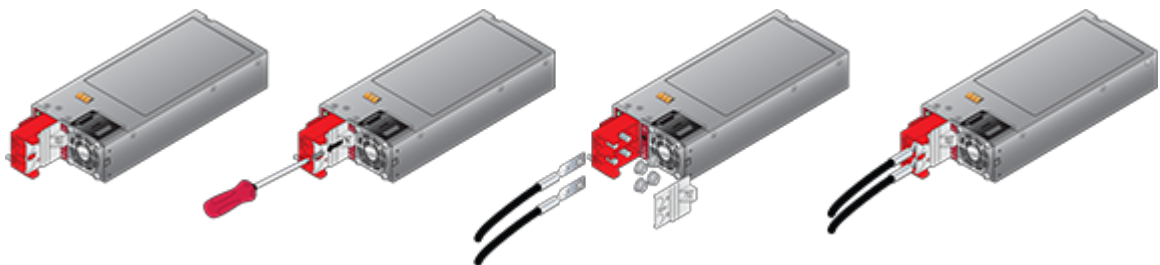

4.3 Connecting Serial and Management Cables

The accessory kit includes the following cables:

- RJ-45 to DB-9 serial adapter cable.
- RJ-45 Ethernet cable.

Table 6: [RJ-45 to DB-9 Connections](#) lists the pin connections of the RJ-45 to DB-9 adapter cable.

Table 6: RJ-45 to DB-9 Connections

RJ-45		DB-9		RJ-45		DB-9	
RTS	1	8	CTS	GND	5	5	GND
DTR	2	6	DSR	RXD	6	3	TXD
TXD	3	2	RXD	DSR	7	4	DTR
GND	4	5	GND	CTS	8	7	RTS

The front panel contains the console, management, and USB ports. [Figure 24: Front Panel Ports](#) displays the ports on the DCS-7050SX-128 switch. [Front Panel](#) displays the front panel of all switches covered by this guide.

Figure 24: Front Panel Ports

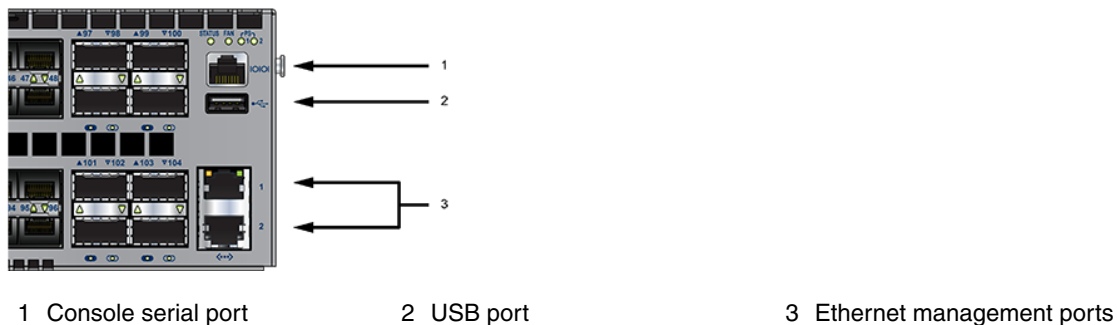

Connect the front panel ports as follows:

- **Console (Serial) Port:** Connect to a PC with the RJ-45 to DB-9 serial adapter cable. The switch uses the following default settings:
 - 9600 baud
 - No flow control
 - 1 stop bit
 - No parity bits
 - 8 data bits
- **Ethernet Management Port:** Connect to 10/100/1000 management network with RJ-45 Ethernet cable.
- **USB Port:** The USB port may be used for software or configuration updates.

 **CAUTION:** Excessive bending can damage interface cables, especially optical cables.

Flexion excessive peut endommager les câbles d'interface, notamment des câbles optiques.

Configuring the Switch

Arista switches ship from the factory in Zero Touch Provisioning (ZTP) mode. ZTP configures the switch without user intervention by downloading a startup configuration file or a boot script from a location specified by a DHCP server. To manually configure a switch, ZTP is bypassed. The initial configuration provides one username (admin) accessible only through the console port because it has no password.

When bypassing ZTP, initial switch access requires logging in as admin, with no password, through the console port. Then you can configure an admin password and other password protected usernames.

This manual configuration procedure cancels ZTP mode, logs into the switch, assigns a password to admin, assigns an IP address to the management port, and defines a default route to a network gateway.

1. Provide power to the switch ([Cabling the Switch](#)).
2. Connect the console port to a PC ([Connecting Serial and Management Cables](#)).

As the switch boots without a startup-config file, it displays the following through the console:

The device is in Zero Touch Provisioning mode and is attempting to download the startup-config from a remote system. The device will not be fully functional until either a valid startup-config is downloaded from a remote system or Zero Touch Provisioning is cancelled. To cancel Zero Touch Provisioning, log in as admin and type 'zerotouch cancel' at the CLI.

```
localhost login:
```

3. Log into the switch by typing **admin** at the login prompt.

```
localhost login: admin
```

4. Cancel ZTP mode by typing **zerotouch cancel**.

IMPORTANT: This step initiates a switch reboot.

```
localhost>zerotouch cancel
```

5. After the switch boots, log into the switch again by typing **admin** at the login prompt.

```
Arista EOS
localhost login:admin
Last login: Fri Mar 15 13:17:13 on console
```

6. Enter global configuration mode.

```
localhost>enable
localhost#config
```

7. Assign a password to the admin username with the **username secret** command.

```
localhost(config)#username admin secret pxq123
```

8. Configure a default route to the network gateway.

```
localhost(config)#ip route 0.0.0.0/0 192.0.2.1
```

9. Assign an IP address (192.0.2.8/24 in this example) to an Ethernet management port.

```
localhost(config)#interface management 1
localhost(config-if-Ma1/1)#ip address 192.0.2.8/24
```

10. Save the configuration by typing **write memory** or **copy running-config startup-config**.

```
localhost#copy running-config startup-config
```

When the management port IP address is configured, use this command to access the switch from a host, using the address configured in step 9:

```
ssh admin@192.0.2.8
```

Refer to the **Arista Networks User Manual** for complete switch configuration information.

Status Indicators

- [Front Indicators](#)
- [Switch Indicators](#)
- [Port Indicators](#)
- [Rear Status Indicators](#)

A.1 Front Indicators

A.1.1 Switch Indicators

Front panel LEDs are located on the right side of the chassis and display system, fan, and power supply status. [Front Panel](#) displays the front panels of all switches covered by this guide.

[Figure 25: System Status Indicators](#) displays the DCS-7050SX-128 front panel LEDs.

Figure 25: System Status Indicators

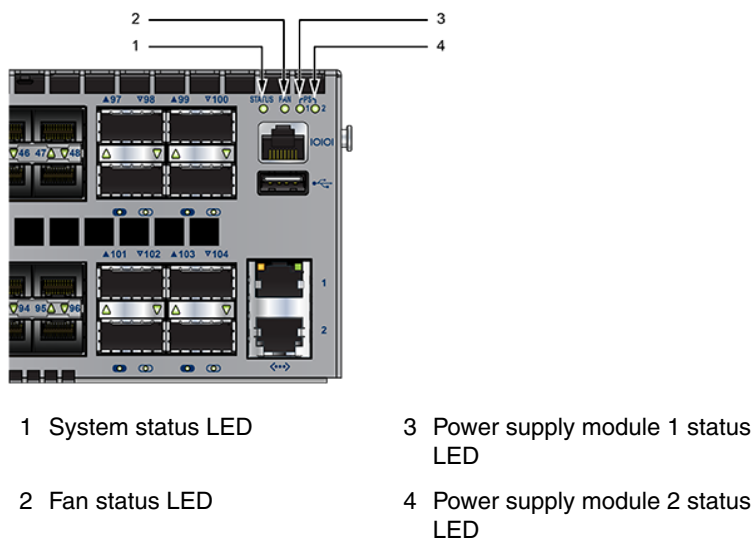

Table 7: Switch Indicators LED States

LED Name	LED State	Device Status
System Status	Blinking Green	System powering up.
	Green	All power supplies and fans are operating normally.
	Blue	The locator function is active.
	Red	A power supply or fan is missing or in a failed state.
Fan Status	Green	All fans are operating normally.

LED Name	LED State	Device Status
	Red	One or more fans are not inserted or have failed.
Power Supply 1 Status Power Supply 2 Status	Off	Power supply is not inserted or is not powered.
	Green	Power supply operating normally.
	Red	Power supply has failed.

 **Note:** Arista fixed systems take approximately 5-10 minutes to boot completely.

A.1.2 Port Indicators

Port LEDs, located in the vicinity of their corresponding ports, provide link and operational status. [Port Indicators](#) displays the Port LED location on the DCS-7050SX-128 switch. [Front Panel](#) displays the port LED locations of all switches covered by this guide.

Figure 26: Port LEDs

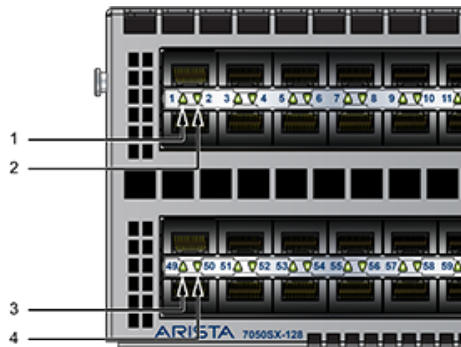

- 1 Upper port (1) LED
- 2 Lower port (2) LED
- 3 Upper port (49) LED
- 4 Lower port (50) LED

[Table 8: Port LED States](#) provides status conditions that correspond to port LED states. Port LED behavior for QSFP+ and SFP+ ports is consistent.

Table 8: Port LED States

LED State	Status
Off	Port link is down.
Green	Port link is up.
Yellow	Port is software disabled.
Flashing Yellow	Port failed diagnostics.

A.2 Rear Status Indicators

Fan and power supply modules are accessed from the rear panel. Each fan and power supply module contains an LED that reports the module status. [Rear Panel](#) displays the rear panel of all switches covered by this guide.

Fan Status LEDs are on the fan modules, as displayed in [Figure 27: Fan Status LED](#).

Figure 27: Fan Status LED

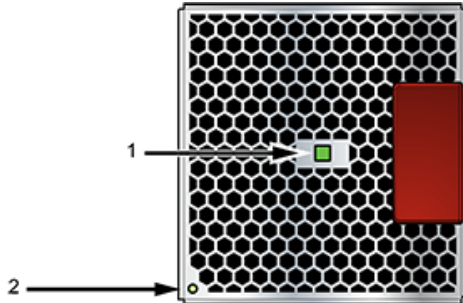

- 1 Module installation indicator
- 2 Fan module status LED

The module installation indicator is green when the fan module is properly installed or red when the module is not fully installed. [Table 9: Fan Status LED States](#) provides status conditions that correspond to fan status LED states.

Table 9: Fan Status LED States

LED State	Status
Off	The fan module is inserted but not receiving power – it may not be properly seated.
Green	The fan is operating normally.
Red	The fan has failed.

The Power Supply Status LEDs are on the power supply modules, as displayed in [Figure 28: Power Supply Status LED](#).

Figure 28: Power Supply Status LED

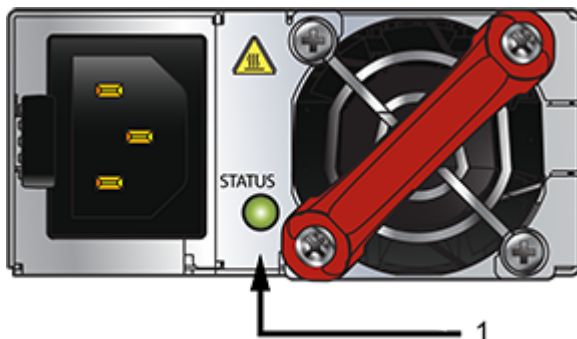

- 1 Power supply status LED

[Table 10: Power Supply Status LED States](#) provides status conditions that correspond to power supply status LED states.

Table 10: Power Supply Status LED States

LED State	Status
Off	Power supply not connected to AC power or not inserted fully.
Green	Power supply operating normally.
Amber	Power supply has overheated or failed.

Parts List

- [Rack Mount Parts](#)
- [Four-Post Rack Mount Parts](#)
- [Two-Post Rack Mount Parts](#)
- [Cables](#)

Each switch provides an accessory kit that contains parts that are required to install the switch. This appendix lists the installation parts contained in the switch accessory kit.

B.1 Rack Mount Parts

Four-post rack mount parts are provided in the accessory kit. Two-post rack mount parts are available through your sales representative.

B.1.1 Four-Post Rack Mount Parts

Figure 29: Four-Post Rack Mount Parts

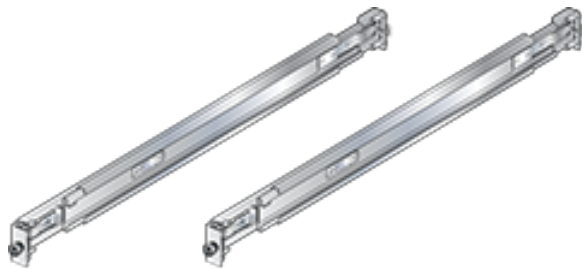

Bracket-Rail Assemblies (2)

B.1.2 Two-Post Rack Mount Parts

Figure 30: Two-Post Rack Mount Parts



Mounting Brackets (Three Hole)

B.2 Cables

Quantity	Description
2	Power cables: IEC-320/C13-C14, 13 A, 250 V, 2 meter
1	RJ-45 Patch Panel Cable, 2 meter
1	RJ-45 to DB9 Adapter Cable, 2 meter

 **Warning:** All provided power cables are for use only with Arista products.

警告

すべての電源コードは提供する製品で使用するためだけを目的としている。

電源コードの他の製品での使用の禁止

Aristaが提供するすべての電源コードは、Aristaの製品でのみ使用してください。

Front Panel

This appendix displays the front panel of all switches covered by this guide.

- [Port-Speed Groups](#)
- [Front Panels](#)

C.1 Port-Speed Groups

Some of the devices shown in this appendix have ports that are grouped together to provide flexibility in configuring Ethernet speeds for the individual members of the group. The default configuration supports the maximum possible Ethernet speed and/or other lower, allowable speeds by the individual members of the group. Care must be taken when inserting optics for lower speed connectivity as further configuration may be required for the port(s) in the group to operate as desired.

For devices that support the port-speed group feature, the groups are called out in the relevant illustrations with the ports in the group identified.

C.2 Front Panels

Figure 31: DCS-7050SX-128

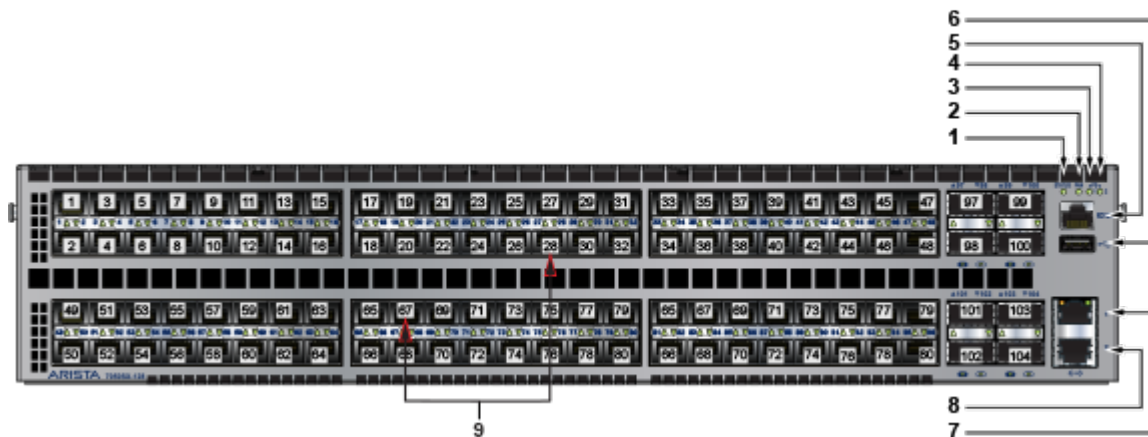

- | | | |
|-----------------------------|-----------------------------|------------------------------|
| 1 System status LED | 4 Power supply 2 status LED | 7 Ethernet management port 1 |
| 2 Fan tray status LED | 5 Console serial port | 8 Ethernet management port 2 |
| 3 Power supply 1 status LED | 6 USB port | 9 Port numbers |

Figure 32: DCS-7050TX-128

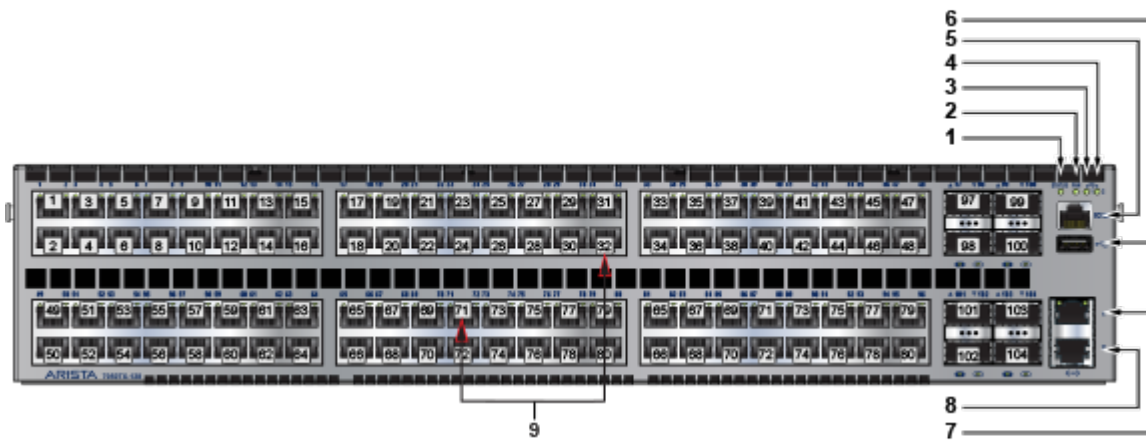

- | | | |
|-----------------------------|-----------------------------|------------------------------|
| 1 System status LED | 4 Power supply 2 status LED | 7 Ethernet management port 1 |
| 2 Fan tray status LED | 5 Console serial port | 8 Ethernet management port 2 |
| 3 Power supply 1 status LED | 6 USB port | 9 Port numbers |

Figure 33: DCS-7050SX2-128

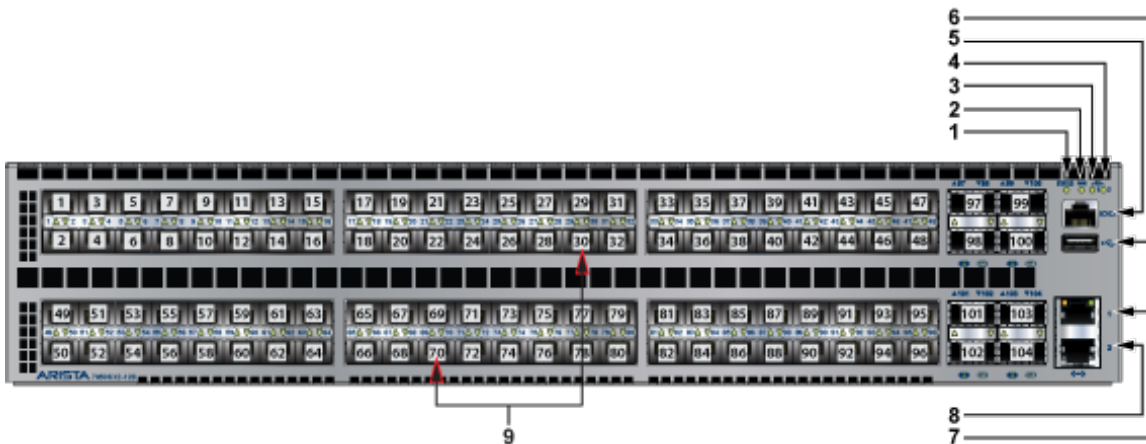

- | | | |
|-----------------------------|-----------------------------|------------------------------|
| 1 System status LED | 4 Power supply 2 status LED | 7 Ethernet management port 1 |
| 2 Fan tray status LED | 5 Console serial port | 8 Ethernet management port 2 |
| 3 Power supply 1 status LED | 6 USB port | 9 Port numbers |

Figure 34: DCS-7050TX2-128

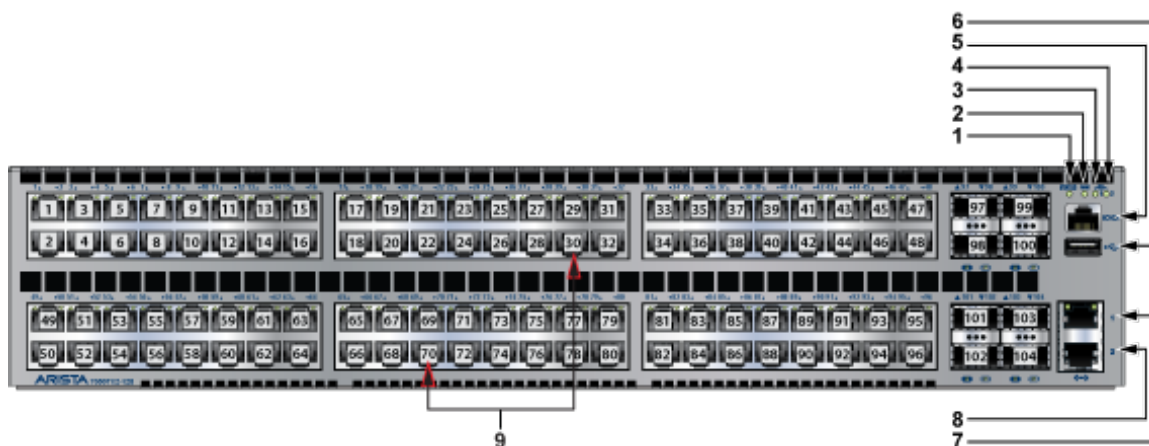

- | | | |
|-----------------------------|-----------------------------|------------------------------|
| 1 System status LED | 4 Power supply 2 status LED | 7 Ethernet management port 1 |
| 2 Fan tray status LED | 5 Console serial port | 8 Ethernet management port 2 |
| 3 Power supply 1 status LED | 6 USB port | 9 Port numbers |

Figure 35: DCS-7250QX-64

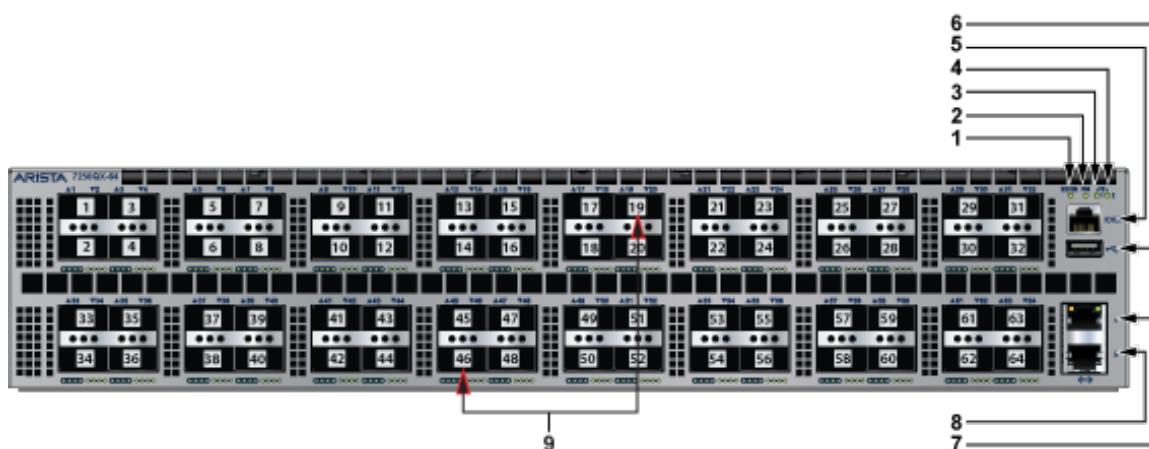

- | | | |
|-----------------------------|-----------------------------|------------------------------|
| 1 System status LED | 4 Power supply 2 status LED | 7 Ethernet management port 1 |
| 2 Fan tray status LED | 5 Console serial port | 8 Ethernet management port 2 |
| 3 Power supply 1 status LED | 6 USB port | Port numbers |

Figure 36: DCS-7260QX-64

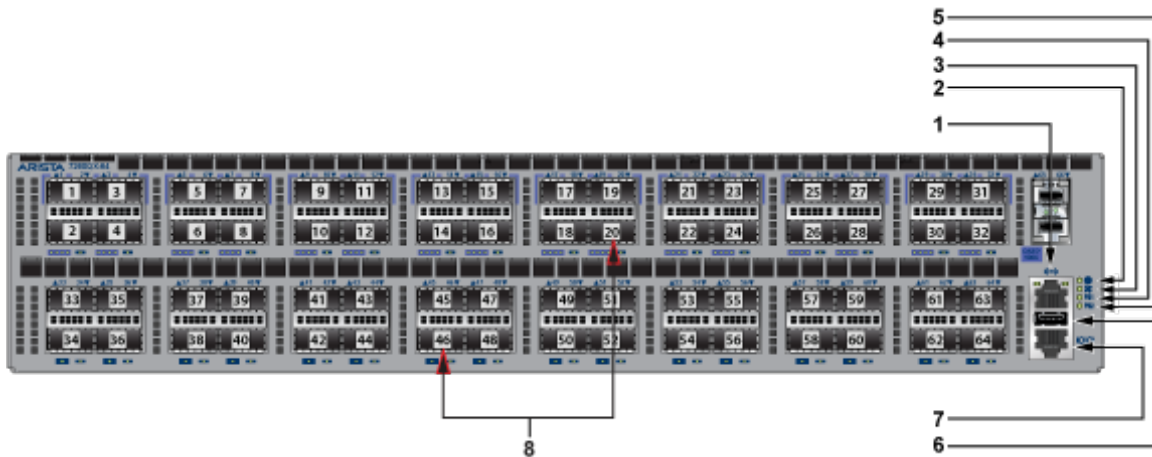

- | | | |
|----------------------------|-----------------------------|-----------------------|
| 1 Ethernet management port | 4 Power supply 1 status LED | 7 Console serial port |
| 2 System status LED | 5 Power supply 2 status LED | 8 Port numbers |
| 3 Fan tray status LED | 6 USB port | |

Figure 37: DCS-7260CX-64

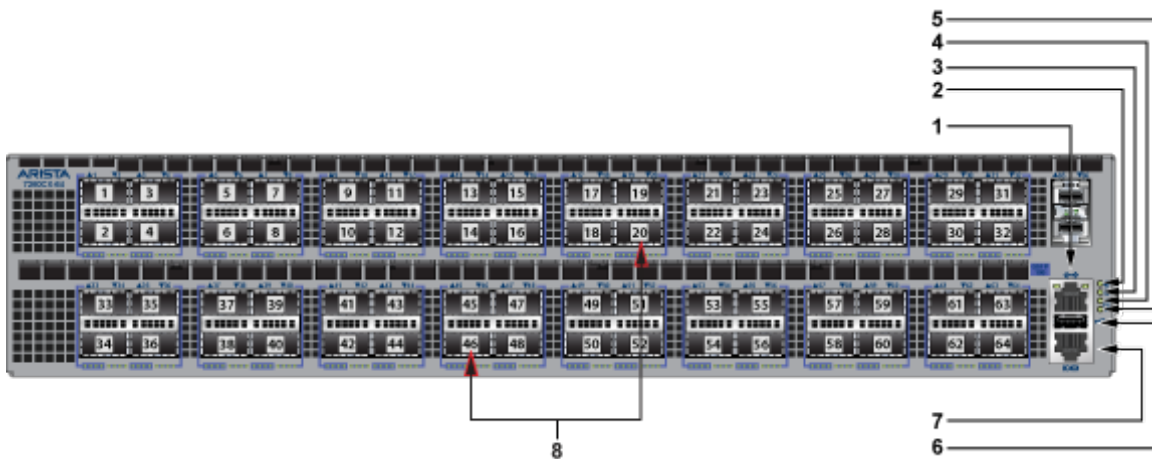

- | | | |
|----------------------------|-----------------------------|-----------------------|
| 1 Ethernet management port | 4 Power supply 1 status LED | 7 Console serial port |
| 2 System status LED | 5 Power supply 2 status LED | 8 Port numbers |
| 3 Fan tray status LED | 6 USB port | |

Figure 38: DCS-7260CX3-64 and DCS-7260CX3-64E



- | | | |
|----------------------------|-----------------------------|-----------------------|
| 1 Ethernet management port | 4 Power supply 1 status LED | 7 Console serial port |
| 2 System status LED | 5 Power supply 2 status LED | 8 Port numbers |
| 3 Fan tray status LED | 6 USB port | |

Figure 39: DCS-7280CR-48

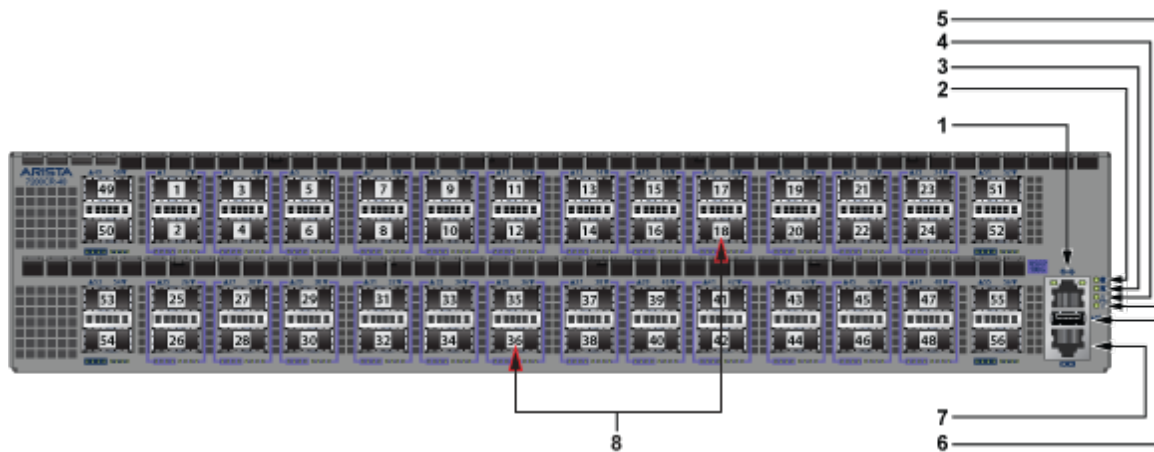

- | | | |
|----------------------------|-----------------------------|-----------------------|
| 1 Ethernet management port | 4 Power supply 1 status LED | 7 Console serial port |
| 2 System status LED | 5 Power supply 2 status LED | 8 Port numbers |
| 3 Fan tray status LED | 6 USB port | |

Figure 40: DCS-7280CR2-60

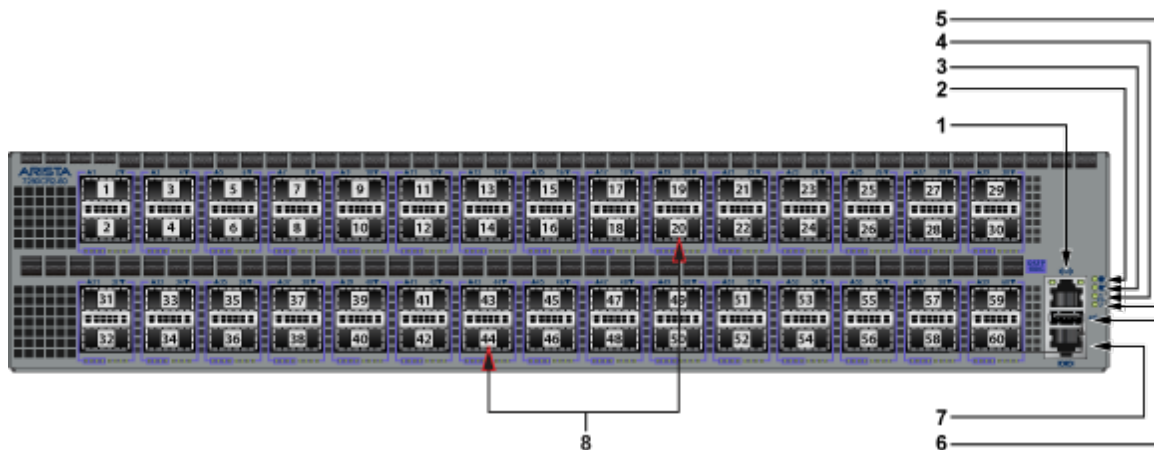

- | | | |
|----------------------------|-----------------------------|-----------------------|
| 1 Ethernet management port | 4 Power supply 1 status LED | 7 Console serial port |
| 2 System status LED | 5 Power supply 2 status LED | 8 Port numbers |
| 3 Fan tray status LED | 6 USB port | |

Figure 41: DCS-7280CR2A-60

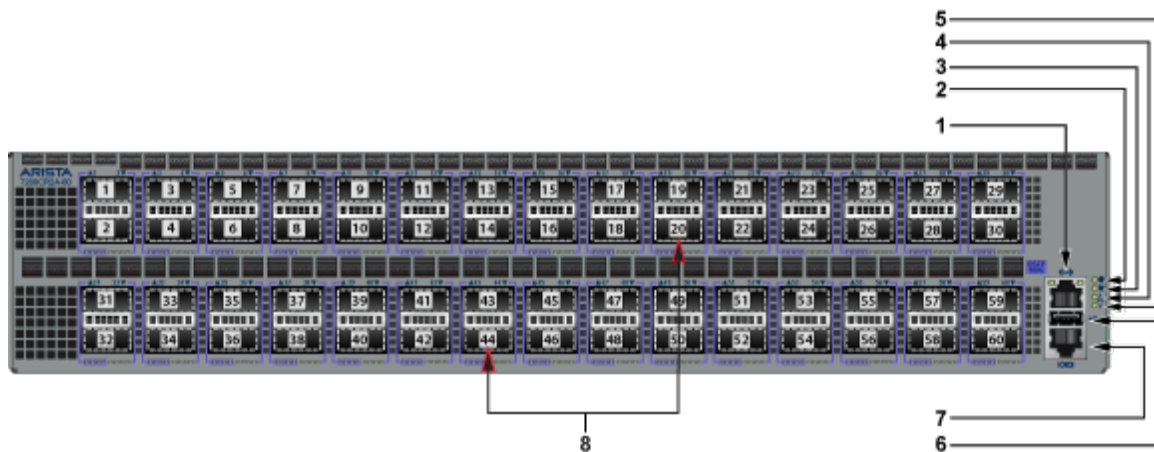

- | | | |
|----------------------------|-----------------------------|-----------------------|
| 1 Ethernet management port | 4 Power supply 1 status LED | 7 Console serial port |
| 2 System status LED | 5 Power supply 2 status LED | 8 Port numbers |
| 3 Fan tray status LED | 6 USB port | |

Figure 42: DCS-7280CR2K-60



- | | | |
|----------------------------|-----------------------------|-----------------------|
| 1 Ethernet management port | 4 Power supply 1 status LED | 7 Console serial port |
| 2 System status LED | 5 Power supply 2 status LED | 8 Port numbers |
| 3 Fan tray status LED | 6 USB port | |

Figure 43: DCS-7170-64C



- | | | |
|----------------------------|-----------------------------|-----------------------|
| 1 Ethernet management port | 4 Power supply 1 status LED | 7 Console serial port |
| 2 System status LED | 5 Power supply 2 status LED | 8 Port numbers |
| 3 Fan tray status LED | 6 USB port | |

Figure 44: DCS-7280QR-C72

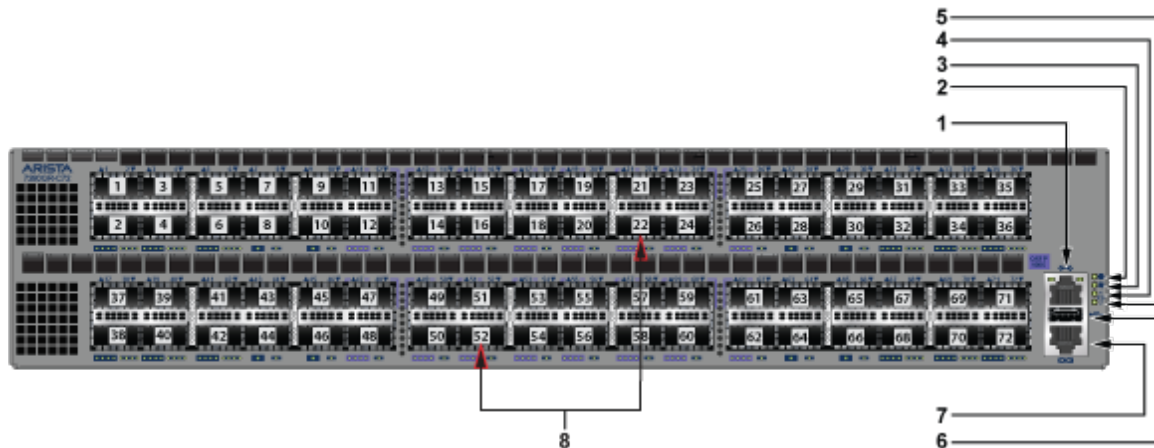

- | | | |
|----------------------------|-----------------------------|-----------------------|
| 1 Ethernet management port | 4 Power supply 1 status LED | 7 Console serial port |
| 2 System status LED | 5 Power supply 2 status LED | 8 Port numbers |
| 3 Fan tray status LED | 6 USB port | |

There are twenty four port groups on the DCS-7280CR3-96. Groups are numbered sequentially from Group 1 (ports 1-4). Each group consists of four individual ports as shown ([Figure 45: DCS-7280CR3-96 / DCS-7280CR3K-96](#)).

Note: Groupings may be different from the one shown based on the software version being used.

Figure 45: DCS-7280CR3-96 / DCS-7280CR3K-96

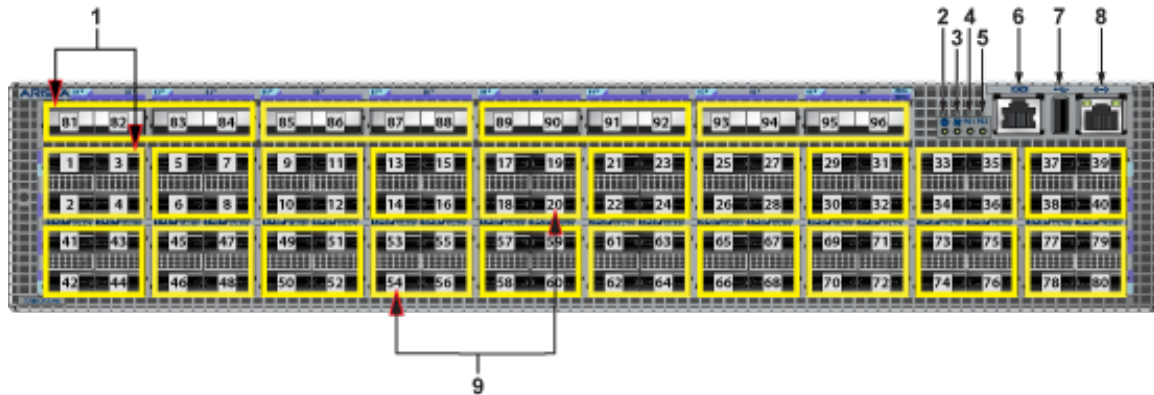

- | | | |
|-----------------------|-----------------------------|----------------------------|
| 1 Port groups | 4 Power supply 1 status LED | 7 USB port |
| 2 System status LED | 5 Power supply 2 status LED | 8 Ethernet management port |
| 3 Fan tray status LED | 6 Console serial port | 9 Port numbers |

There are twenty four port groups on the DCS-7050SX3-96YC8. Groups are numbered sequentially from Group 1 (ports 1-4). Each group consists of four individual ports as shown ([Figure 46: DCS-7050SX3-96YC8](#)).

Note: Groupings may be different from the one shown based on the software version being used.

Figure 46: DCS-7050SX3-96YC8

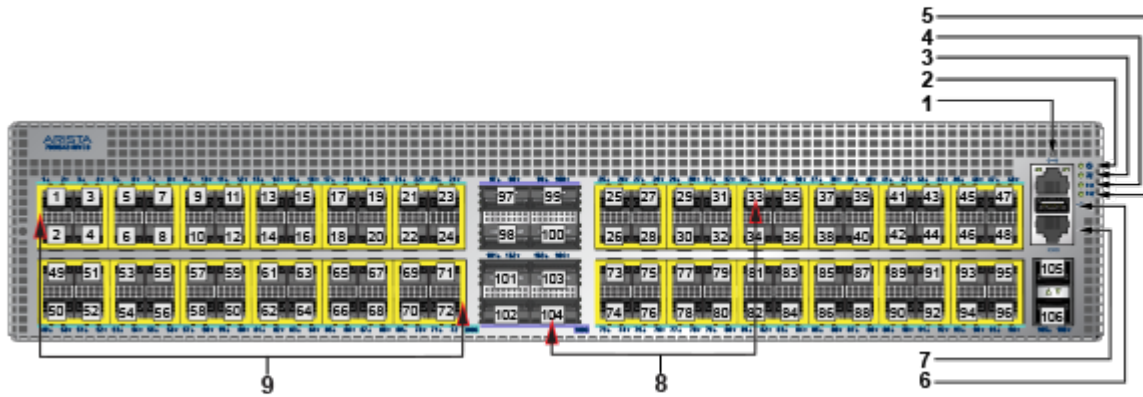

- | | | |
|----------------------------|-----------------------------|-----------------------|
| 1 Ethernet management port | 4 Power supply 1 status LED | 7 Console serial port |
| 2 System status LED | 5 Power supply 2 status LED | 8 Port numbers |
| 3 Fan tray status LED | 6 USB port | 9 Port groups |

Rear Panel

This appendix displays the rear panel of all switches covered by this guide. Depending on the power supply and fan modules installed, the rear panel on your switch may appear slightly different.

Figure 47: Models Without Separation Between Fans 1 and 2

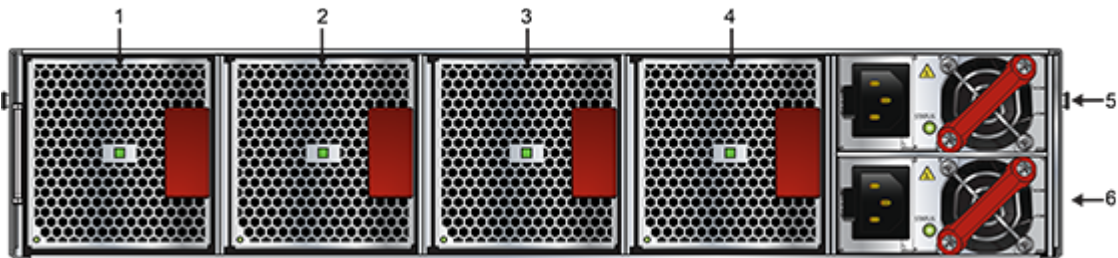

- | | | |
|----------------|----------------|-------------------------|
| 1 Fan Module 1 | 3 Fan Module 3 | 5 Power Supply Module 1 |
| 2 Fan Module 2 | 4 Fan Module 4 | 6 Power Supply Module 2 |

Figure 48: Models With Ground Attach Point Between Fans 1 and 2

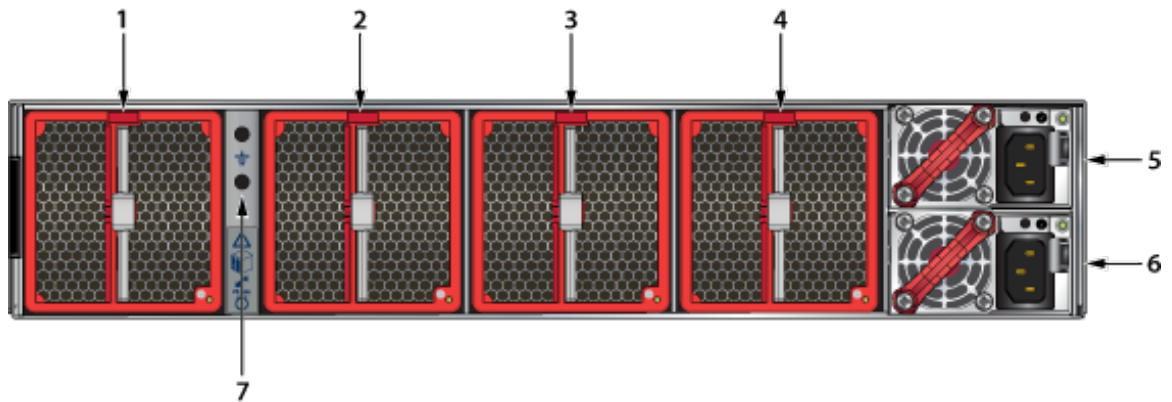

- | | | |
|----------------|-------------------------|----------|
| 1 Fan Module 1 | 4 Fan Module 4 | 7 Ground |
| 2 Fan Module 2 | 5 Power Supply Module 1 | |

3 Fan Module 3

6 Power Supply Module 2

Figure 49: Models With Separation Between Fans 1 and 2 (no ground)

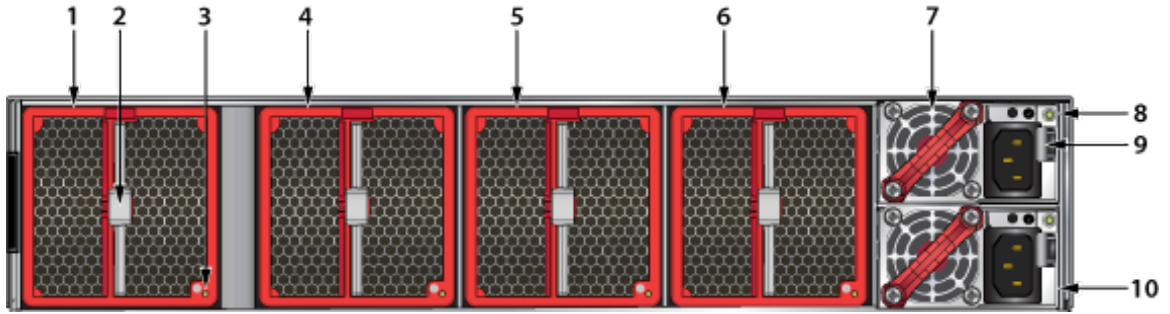

1 Fan Module 1

2 Release

3 Status LED

4 Fan Module 2

5 Fan Module 3

6 Fan Module 4

7 Power Supply Module 1

8 Status LED

9 Release

10 Power Supply Module 2

Regulatory Model Numbers

This appendix lists the Regulatory Model Numbers (RMNs) for the product models for the switches described in this document.

Table 11: Regulatory Model Numbers and Product Numbers

Regulatory Model Number (RMN)	Product Name(s)
N/A	DCS-7050SX-128
N/A	DCS-7050TX-128
N/A	DCS-7050SX2-128
N/A	DCS-7050TX2-128
N/A	DCS-7250QX-64
N/A	DCS-7260QX-64
AN1509	DCS-7260CX-64
AN1619	DCS7260CX3-64
AN1510	DCS-7280CR-48
AN1617	DCS-7280CR2-60, DCS-7280CR2A-60, DCS-7280CR2K-60
AN1621	DCS-7170-64C
AN1616	DCS-7280QR-C72
AN1718	DCS-7280CR3-96, DCS-7280CR3K-96
AN1719	DCS-7050SX3-96YC8

Taiwan RoHS Information

This appendix provides Taiwan RoHS information for switches covered by this guide.

For Taiwan BSMI RoHS Table, go to <https://www.arista.com/assets/data/pdf/AristaBSMIroHS.pdf>.

