

# ARISTA

## Quick Start Guide



### 7388X5 Series Modular Data Center Switches

**Arista Networks**

[www.arista.com](http://www.arista.com)

DOC-05054-02

<b>Headquarters</b>	<b>Support</b>	<b>Sales</b>
5453 Great America Parkway, Santa Clara, CA 95054 USA +1-408 547-5500	+1-408 547-5502 +1-866 476-0000	+1-408 547-5501 +1-866 497-0000
<a href="https://www.arista.com/en/">https://www.arista.com/en/</a>	<a href="mailto:support@arista.com">mailto:support@arista.com</a>	<a href="mailto:support@arista.com">mailto:support@arista.com</a>

© Copyright 2024 Arista Networks, Inc. All rights reserved. The information contained herein is subject to change without notice. The trademarks, logos and service marks ("Marks") displayed in this documentation are the property of Arista Networks in the United States and other countries. Use of the Marks are subject to Arista Network Term of Use Policy, available at <http://www.arista.com/en/terms-of-use>. Use of marks belonging to other parties is for informational purposes only.

---

# Contents

<b>Chapter 1: Overview.....</b>	<b>1</b>
1.1 Scope.....	1
1.2 Receiving and Inspecting the Equipment.....	1
1.3 Installation Process.....	1
1.4 Safety Information.....	1
1.5 Obtaining Technical Assistance.....	2
1.6 Specifications.....	3
<b>Chapter 2: Preparation.....</b>	<b>5</b>
2.1 Site Selection.....	5
2.2 Tools Required for Installation.....	6
2.3 Electrostatic Discharge (ESD) Precautions.....	6
<b>Chapter 3: Rack Mounting the Switch.....</b>	<b>9</b>
3.1 Shelf Installation.....	9
3.2 Mounting Ears Installation.....	10
3.3 Switch Insertion into Rack.....	10
<b>Chapter 4: Powering the Modular Switch.....</b>	<b>13</b>
4.1 Cabling the AC Power Supply.....	15
4.1.1 Grounding the Switch.....	15
4.1.2 Connecting Power Cables to an AC Power Supply.....	16
4.2 DC Power Supplies.....	17
4.2.1 Wire and Lug Preparation.....	17
4.2.2 Connecting a DC Power Supply to Power Source.....	18
<b>Chapter 5: Connecting Serial and Management Cables.....</b>	<b>21</b>
5.1 Connecting Supervisor Cables.....	21
5.2 Connecting Linecard Modules and Cables.....	22
<b>Chapter 6: Configuring the Switch.....</b>	<b>23</b>
<b>Appendix A: Status Indicators.....</b>	<b>25</b>
A.1 Supervisor Module Status Indicators.....	25
A.2 Linecard Module Indicators.....	26
A.3 Fan Module Status Indicators.....	27
A.4 Power Supply Status Indicators.....	29
<b>Appendix B: Parts List.....</b>	<b>31</b>
B.1 Parts Used in All Configurations.....	31
B.2 Four-Post Rack Mount Parts.....	31

---

<b>Appendix C: Front Panels.....</b>	<b>33</b>
<b>Appendix D: Rear Panels.....</b>	<b>35</b>
<b>Appendix E: Line Cards.....</b>	<b>37</b>
<b>Appendix F: Maintenance and Field Replacement.....</b>	<b>39</b>
F.1 Switch Card Module.....	39
F.1.1 Removing Switch Card Module.....	39
F.1.2 Inserting Switch Card Module.....	39
F.2 Power Supplies.....	40
F.2.1 Removing a Power Supply.....	40
F.2.2 Installing a Power Supply.....	41
F.3 Fan Modules.....	41
F.3.1 Removing a Fan Module.....	41
F.3.2 Installing a Fan Module.....	42
F.4 Supervisor Module.....	42
F.4.1 Removing Supervisor Module.....	42
F.4.2 Installing Supervisor Module.....	43
F.5 Linecards.....	43
F.5.1 Removing Linecard.....	44
F.5.2 Installing Linecard.....	45
F.6 Optical Transceivers.....	45
<b>Appendix G: Regulatory Model Numbers.....</b>	<b>47</b>
<b>Appendix H: Taiwan RoHS Information.....</b>	<b>49</b>

## Overview

---

### 1.1 Scope

This guide is intended for properly trained service personnel and technicians who need to install the following Arista Networks Data Center Switches:

- DCS-7388X5



**Important:** Only qualified personnel should install, service, or replace this equipment.

Seul le personnel qualifié doit installer, service, ou remplacer cet équipement.

### 1.2 Receiving and Inspecting the Equipment

Upon receiving the switch, inspect the shipping boxes and record any external damage. Retain packing materials if you suspect that part of the shipment is damaged; the carrier may need to inspect them.

If the boxes were not damaged in transit, unpack them carefully. Ensure that you do not discard any accessories that may be packaged in the same box as the main unit.

Inspect the packing list and confirm that you received all listed items. Compare the packing list with your purchase order for a [list of components](#) included with the switch.

### 1.3 Installation Process

The following tasks are required to install and use the switch:

1. [Site Selection](#).
2. [Assembling Tools Required for Installation](#).
3. [Rack Mounting the Switch](#).
4. [Powering the Modular Switch](#).
5. [Connecting Serial and Management Cables](#).
6. [Configuring the Switch](#).

### 1.4 Safety Information

Refer to the Arista Networks document Safety Information and Translated Safety Warnings available at: <https://www.arista.com/en/support/product-documentation>.



**Important:**

Class 1 Laser Product: This product has provisions to install Class 1 laser transceivers that provides optical coupling to the communication network. Once a Class 1 laser product is installed, the equipment is a Class 1 Laser Product (Appareil à Laser de Classe 1). The customer is responsible for selecting and installing the Class 1 laser transceiver and for insuring that the Class 1 AEL (Allowable Emission Limit) per EN/IEC 6-825, CSA E60825-1,

---

and Code of Federal Regulations 21 CFR 1040 is not exceeded after the laser transceiver have been installed. Do not install laser products whose class rating is greater than 1. Refer to all safety instructions that accompanied the transceiver prior to installation. Only Class 1 laser devices certified for use in the country of installation by the cognizant agency are to be utilized in this product.

Produit Laser de classe 1: Ce produit a des dispositions pour installer des émetteurs-récepteurs de laser de classe 1 qui offre de couplage au réseau de communication optique. Une fois un produit laser de classe 1 est installé, l'équipement est un produit Laser de classe 1 (Appareil à Laser de Classe 1). Le client est responsable pour sélectionner et installer l'émetteur/récepteur de laser de classe 1 et pour assurer que la classe 1 AEL (limite d'émission admissible) par EN/IEC 60825, CSA E60825-1, et Code des règlements fédéraux 21 CFR 1040 ne soit pas dépassée après avoir installé l'émetteur/récepteur de laser. Ne pas installer des appareils à laser dont la cote de classe est supérieure à 1. Voir toutes les consignes de sécurité qui ont accompagné l'émetteur-récepteur avant l'installation. Seuls appareils laser de classe 1 certifiés pour une utilisation dans le pays d'installation par l'organisme compétent doivent être utilisées dans ce produit.



**Important:**

Ultimate disposal of this product must be handled in accordance with all national laws and regulations.

Aucune pièce réparable par l'utilisateur à l'intérieur. Confiez toute réparation à un technicien qualifié.

The fabric module requires special handling when removing, inserting, or handling the component. Appendix F provides instructions for handling fabric modules.

## 1.5 Obtaining Technical Assistance

Any customer, partner, reseller or distributor holding a valid Arista Service Contract can obtain technical support in any of the following ways:

- **Email:** [support@arista.com](mailto:support@arista.com). This is the easiest way to create a new service request. Include a detailed description of the problem and the output of “show tech-support”.
- **Web:** <https://www.arista.com/en/support> A support case may be created through the support portal on our website. You may also download the most current software and documentation, as well as view FAQs, Knowledge Base articles, Security Advisories, and Field Notices.
- **Phone:** +1 866-476-0000 or +1 408-547-5502.



**Important:**

No user serviceable parts inside. Refer all servicing to qualified service personnel.

Aucune pièce réparable par l'utilisateur à l'intérieur. Confiez toute réparation à un technicien qualifié.

## 1.6 Specifications

The following table lists specifications of Arista Data Center modular switches and components covered by this guide.

**Table 1: DCS-7388X5 Modular Switch and Component Specifications**

Attribute	Specification
<b>Height</b>	4 RU: 174 mm (7.0 inches)
<b>Width</b>	440 mm (17.3 inches)
<b>Depth</b>	680 mm (26.8 inches)
<b>Weight: Fully Loaded</b>	49.4 kg (109 lbs)
<b>Input Power (per circuit)</b>	
AC Power	200 - 277 VAC, 13.5 A (200 VAC), 50 or 60 Hz
DC Power	-40 VDC to -72 VDC, 42 A (-48 V) <sup>1</sup> 240 VDC to 380 VDC <sup>2</sup>
<b>Branch Circuit Protection</b>	
AC Power	20 A
<b>Input Power Circuits</b>	2 to 4 circuits
<b>Operating Temperature</b>	0° to 40°C (32° to 104°F)
<b>Storage Temperature</b>	-40° to 70°C (-40° to 158°F)
<b>Operating Altitude</b>	0 to 3,000 meters (0 to 10,000 feet)
<b>Relative Humidity</b>	5 to 90%
<b>Cooling</b>	2000 W maximum

<sup>1</sup>: (PWR-2411-DC-RED)

<sup>2</sup>: (PWR-2421-DC-HV)

The following table lists power specifications of modular switch components.

**Table 2: 7388 Modular Switch and Component Power Specifications**

Module Type	Part Number	Power Draw: Typical / Maximum
Supervisor	DCS-7388-SUP, DCS-7388-SUP-D	33 W / 53 W
Linecard	DCS-7388-16CD, DCS-7388-16CD2	2.2 W <sup>1</sup> / 4.4 W <sup>2</sup>
	DCS-7388-8DR	17 W <sup>1</sup> / 39 W <sup>2</sup>
	DCS-7388-8D	142 W <sup>1</sup> / 161 W <sup>2</sup>
Switch Card (excluding fans)	DC-7388X5-SC	372 W / 457 W
Power Supplies	PWR-2421-HV	
	PWR-2411-DC-RED	
7388 Series System	Full chassis loaded with 1x DCS-7388-SUP-D supervisor 1x DC-7388X5-SC switch card 8x DCS-7388-8D linecards 5x Fans 2x PWR-2401-AC power supplies	3458 W <sup>2</sup>

<sup>1</sup>: Excluding optics.

<sup>2</sup>: With 15 W optics.



## Preparation

### 2.1 Site Selection

The following criteria should be considered when selecting a site to install the switch:

**Floor Space:** Install the switch in an area that provides adequate clearance for removing front and rear components. The following diagram provides switch clearance requirements.

**Figure 1: Switch Component Removal Footprint**

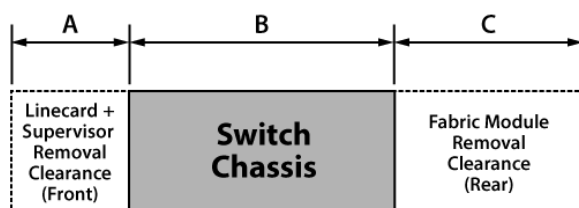

**Table 3: Clearance requirements and footprint dimensions**

Dimension	DCS-7388X5
A	25.4 cm (10 inches)
B	66.0 cm (26.0 inches)
C	55.9 cm (22.0 inches)

- **Temperature and Ventilation:** For proper ventilation, install the switch where there is ample airflow to the front and back of the switch. The temperature should not go below 0° or exceed 40°C.



**Important:**

To prevent the switch from overheating, do not operate it in an area where the ambient temperature exceeds 40°C (104°F).

Pour empêcher l'interrupteur de surchauffer, ne pas utiliser il dans une zone où la température ambiante est supérieure à 40°C (104°F).

- **Airflow Orientation:** Determine airflow direction of the fan modules and power supply modules. Fan and power supply module handles indicate airflow direction.



**Note:** All power supplies may not be supported by the switch configuration you have.

- **Rack Space:** Install the switch in a 19" rack or cabinet. The switch height depends on the switch model, as specified in [Specifications](#). Verify that the removal clearances provide adequate space for the power and data cables that connect to the switch.

When mounting the switch in a partially filled rack, load the rack from bottom to top, with the heaviest equipment at the bottom. Load the switch at the bottom if it is the only item in the rack.

---

The accessory kit provides mounting brackets for four-post racks. Two-post mounting racks are not supported.



**Important:**

All power input plug-socket combinations must be accessible at all times; they provide the primary method of disconnecting power from the system.

Toutes les combinaisons de fiche-prise d'entrée de puissance doivent être accessibles en tout temps; ils fournissent le principal moyen de coupure d'alimentation du système.

- **Power Requirements:** Power requirements vary by switch. Refer to [Table 1: DCS-7388X5 Modular Switch and Component Specifications](#) and [Table 2: 7388 Modular Switch and Component Power Specifications](#) for information regarding your specific system.

Multiple circuits provide redundancy protection. The switch power supply has a Saf-D connector.

- **Other Requirements:** Select a site where liquids or objects cannot fall onto the equipment and foreign objects are not drawn into the ventilation holes. Verify these guidelines are met:
  - Clearance areas to the front and rear panels allow for unrestricted cabling.
  - All front and rear panel indicators can be easily read.
  - AC power cords can reach from the AC power outlet to the connectors on the front panel.



**Important:**

Disconnecting power to all input sockets is required to completely power off the unit.

Coupure d'alimentation sur toutes les entrées il faut pouvoir complètement l'appareil hors tension.

## 2.2 Tools Required for Installation

Each switch provides an accessory kit that contains parts for installing the switch into a four-post rack. Two-post rack mount parts are available through your sales representative. Accessory kits do not include screws, nuts, or bolts for attaching the switch to a conventional rack.

In addition to the accessory kit, the following tools are required to install a modular switch:

### All Racks

- Mechanical device capable of lifting chassis being installed as indicated in [Table 1: DCS-7388X5 Modular Switch and Component Specifications](#).

### Four-Post Tool-less Rack

No additional equipment required.

### Four-Post Conventional Rack

- Screws or rack mounting nuts and bolts.
- Screwdriver.

## 2.3 Electrostatic Discharge (ESD) Precautions

Observe these guidelines to avoid ESD damage when installing or servicing the switch.

- Assemble or disassemble equipment only in a static-free work area.
- Use a conductive work surfaces (such as an antistatic mat) to dissipate static charge.
- Wear an ESD wrist strap to dissipate static charge accumulation.

- Minimize handling of assemblies and components.
- Keep replacement parts in their original static-free packaging.
- Remove all plastic, foam, vinyl, paper, and other static-generating materials from the work area.
- Use tools that do not create ESD.



## Rack Mounting the Switch

---

The switch must be mounted in a four-post rack. Perform the following tasks to mount the switch.

- Attach the left and right shelf to the rack, adjusting the length of the shelves as needed. You must allocate 4RU rack space starting from the top of the shelf for switch placement ([Shelf Installation](#)).
- Attach the rack mounting ears to the switch ([Mounting Ears Installation](#)).
- Insert the switch and secure it to the rack ([Switch Insertion into Rack](#)).



**Note:** Components are designed for tool-less installation in square-hole racks.

### 3.1 Shelf Installation

The four-post mount accessory kit contains these components:

- Left Shelf and Right Shelf
- Rack mounting ears

Follow the steps listed below to attach the shelves to the rack.



**Note:** Illustrations use a representative 4 RU chassis.

1. Extend the sliding end of each shelf so that it can be placed on the rack.

**Figure 2: Attaching Shelves to the Rack (Right Shelf Shown)**

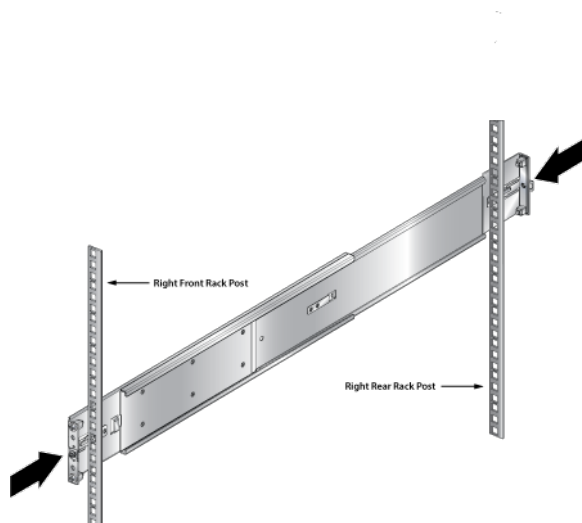

2. Move the sliding end of each shelf so that the shelf fits snug and level on to the rack and secure the shelves using the screws to the rack. (Figure 3-2-left and Figure 3-2-right).



**Note:** You must ensure that the shelves are installed at the same level in the rack.

**Figure 3: Adjusting Shelves to Fit onto the Rack (Right Shelf Shown)**

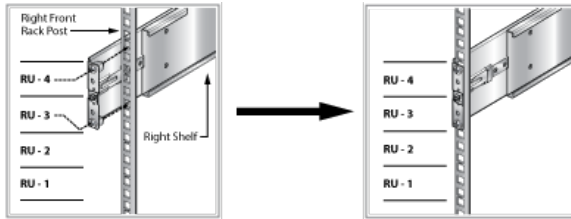

**Figure 4: Switch Shelves Installed**

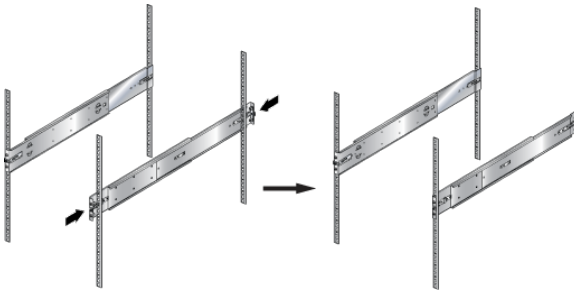

## 3.2 Mounting Ears Installation

The following figure shows the rack mounting ears, which secure the switch top to the rack. Attach the two rack mounting ears to each side of the switch. The inner side of each ear may include a latch to the locking mechanism that secures the ear to the rack. The two rack mounting ears are identical and will attach to the switch such that the securing screws are on the outside of the switch as shown.

**Figure 5: Rack Mounting Ears**

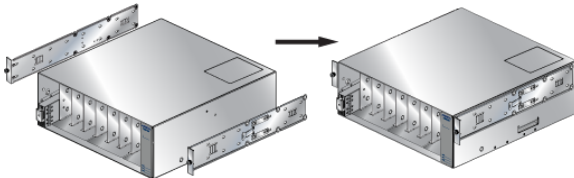

## 3.3 Switch Insertion into Rack

Use a lift to raise and align the switch with the installed shelves and insert the rollers on the rack mount ears into the shelves' channels. Push and slide the switch into the rack to secure.



**Note:** The rack mounting ears use only the top two rack units but you must allocate four rack units from the top of the shelves for the switch.

**Figure 6: Inserting the Switch**

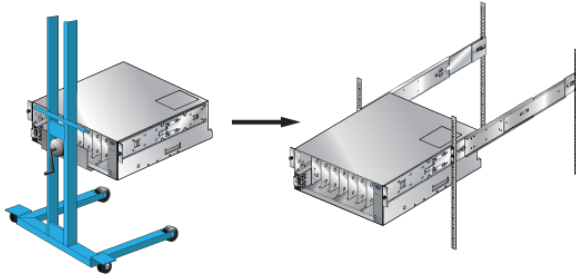

**Figure 7: Securing the Switch**

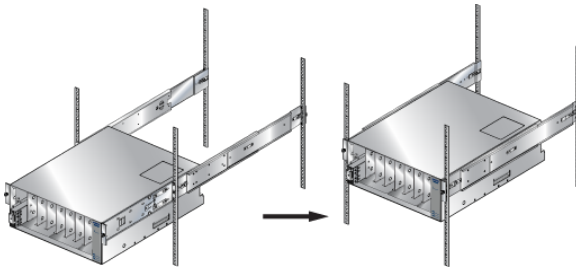





## Powering the Modular Switch

The switch operates with multiple power supplies. The following table lists the quantity of modules each chassis can contain and the minimum operating requirements for each model.



**Important:**

Installation of this equipment must comply with local and national electrical codes. If necessary, consult with the appropriate regulatory agencies and inspection authorities to ensure compliance.

Installation de cet équipement doit être conformes aux codes électriques locaux et nationaux. Si nécessaire, consulter les organismes de réglementation appropriés et des autorités de contrôle pour assurer la conformité.

**Table 4: Power Supply Capacity and Requirements for 7388X5 Series Modular Switches**

Switch Model	Chassis Capacity (Power Supply Units)	Minimum Operating Requirements (non-redundant power)
DCS-7388X5	4	1 active circuit



**Important:**

Each power supply requires input branch circuit protection in compliance with AHJ requirements.

Chaque alimentation nécessite une protection du circuit de la branche d'entrée conformément aux exigences de l'AHJ.

The power supplies are located on the [Rear Panels](#) of the switch. Unpopulated power supply bays must be covered using the appropriate “blank” for the switch.

This chapter includes sections that describe procedure for grounding and cabling power supplies. After completing the instructions for your switch, proceed to [Connecting Serial and Management Cables](#).



**Important:**

Read all installation instructions before connecting the system to the power source.

Lire toutes les instructions d'installation avant de brancher le système à la source d'alimentation.

- Non-Redundant Configuration: Provide power to the minimum required power inputs.
- Redundant Power Supply Configuration: Connecting power to modules in excess of minimum requirements protects the switch against failed modules and can provide grid-level redundancy.
- Power down the Switch: Remove all power cords from the power input sockets.



**Important:**

This equipment must be grounded. Never defeat the ground conductor. This unit requires over-current protection.

---

Cet équipement doit être mis à la terre. Ne jamais modifier le conducteur de terre. Cet appareil nécessite de protection contre les surintensités.

## 4.1 Cabling the AC Power Supply

### 4.1.1 Grounding the Switch

After mounting the switch into the rack, connect the switch to the data center ground. The following figure displays the location of the grounding pads located on the rear of the switch.

**Figure 8: Grounding location and ESD attach points (rear)**

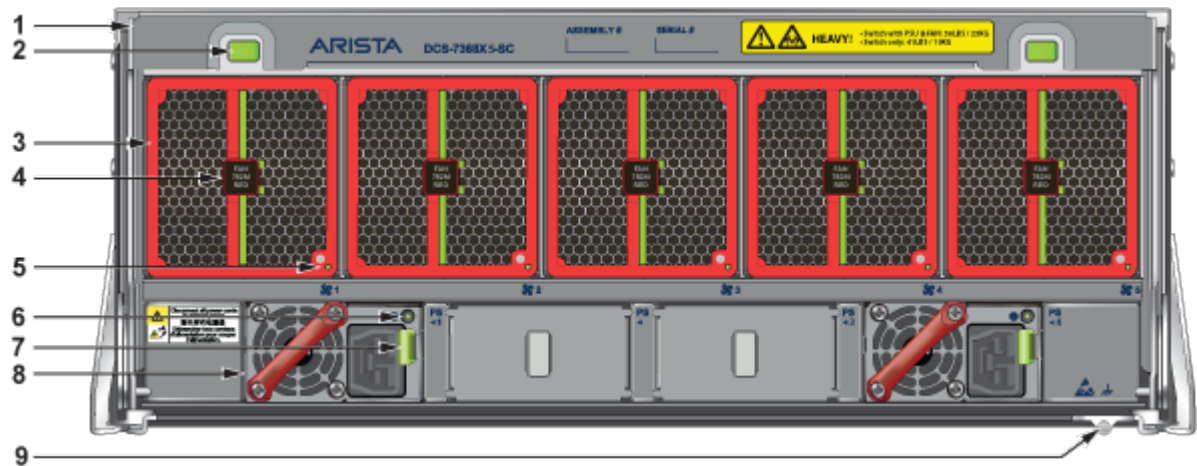

1 Switch Card Module Release Handle	4 Fan Module Release	7 PSU Release
2 Switch Card Module Release Buttons	5 Fan Status LED	8 PSU
3 Fan	6 PSU Status LED	9 Ground



#### Important:

Grounding wires and grounding lugs (M4 x 0.7) are not supplied. Wire size should meet local and national installation requirements. Commercially available 6 AWG wire is recommended for installations in the U.S.

À la terre et de mise à la terre fils cosses (M4 x 0.7) ne sont pas fournis. Calibre des fils doit satisfaire des exigences de l'installation locale et nationale. Disponible dans le commerce des câbles 6 AWG sont recommandé pour les installations aux États-Unis.

After the switch is grounded, ESD wrist straps can be grounded by connecting them to the ESD port on the front of the switch.

**Figure 9: Grounding location and ESD attach point (Front)**

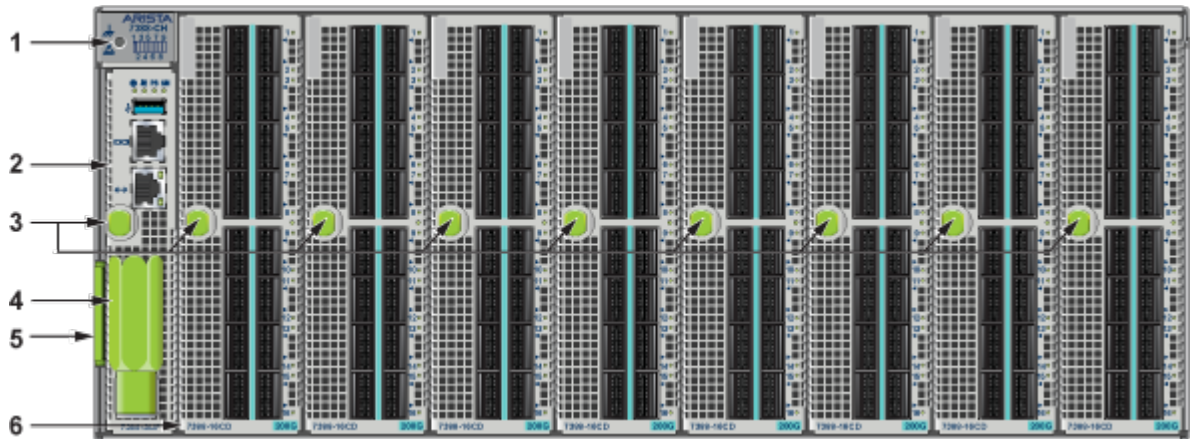

- |                     |   |                                     |
|---------------------|---|-------------------------------------|
| 1 ESD attach point  | 3 Supervisor and Linecard Ejector Handle (Release) and Button | 5 Pull Tag (for Switch Information) |
| 2 Supervisor Module | 4 Torque Clutch Removal Tool                                  | 6 Linecard                          |

#### 4.1.2 Connecting Power Cables to an AC Power Supply

The following figure displays an AC power supply module, including the power input socket.

**Figure 10: Power Input Sockets**

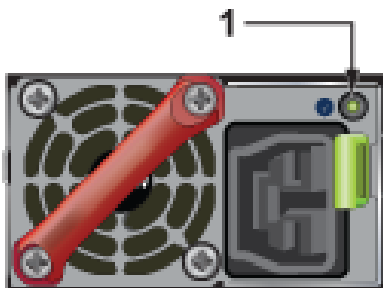

- 1 Power Supply Status LED

The power supplies require a SAF-D cable for connection.

To insert a power cable:

1. Pull the retaining clip back on each power input socket.

 **Note:** The retaining clip is optional (if provided).

2. Plug the power cables into the sockets.
3. Adjust the retaining clips if needed for your power cords (if retaining clip was provided).
4. Push the retaining clip back down over the cable (if retaining clip was provided).

## 4.2 DC Power Supplies

The following DC power supplies are supported.

- PWR-2411-DC-RED
- PWR-2421-HV

The following image displays the DC power supply.

**Figure 11: DC Power Supply Examples**

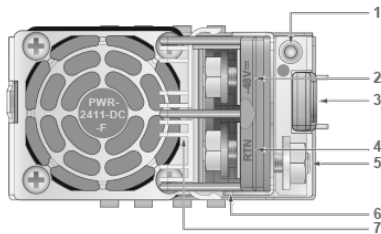

- |                           |                                 |                 |
|---------------------------|---------------------------------|-----------------|
| 1 Power Supply Status LED | 4 RTN (Battery return) Terminal | 7 Plastic Cover |
| 2 -48V Terminal           | 5 Protective Earth Terminal     |                 |
| 3 Release                 | 6 Plastic Cover Handle          |                 |



**Important:** A disconnect device must be provided as part of the installation .

Un dispositif de sectionnement doit être fourni dans le cadre de l'installation.



**Important:** Ensure power is removed from DC circuits before performing any installation actions. Locate the disconnect device, circuit breakers or fuses on DC power lines servicing the circuits. Turn off the power line circuits or remove the fuses.

Pouvoir assurer qu'il est retiré de circuits DC avant d'effectuer des actions d'installation . Localiser les disjoncteurs ou des fusibles sur les lignes de courant continu desservant les circuits. Coupez les circuits de lignes d'alimentation ou retirer les fusibles.



**Important:** Wire size must comply with local and national requirements and electrical codes. Use only copper wire.

Le calibre du fil doit être conforme aux exigences locales et nationales et les codes électriques. Utiliser du fil de cuivre.



**Important:** Apply ground connection to the switch first during installation and remove last when removing power.

Appliquer connexion à la terre à l'interrupteur premier lors de l'installation et de supprimer la dernière alimentation lors du débranchement.

### 4.2.1 Wire and Lug Preparation

Before performing any installation actions, ensure power is removed from DC circuits by turning off the power line servicing the circuits. Prepare the stranded wiring before you begin a DC power installation.



**Note:** Stranded copper wiring is required and should meet local and national installation requirements. Wires and grounding lugs are not supplied.

1. Attach an ESD grounding strap.

2. Prepare the stranded copper wiring for the power supply to be used. The following table provides wiring, lug, and tightening torque information for the power supplies covered in this guide.

**Table 5: Wiring, Lug, and Tightening Torques for DC PSUs**

PSU	Wire Size <sup>(1)</sup>		Lug Type <sup>(2)</sup>	Tightening Torque	
	(AWG)	(mm <sup>2</sup> )		N•m	in.•lbs.
PWR-2411-DC	2 - 4	35.0 - 25.0		2.7	24

<sup>1</sup> Unless otherwise noted, wire size applies to -48V, Battery return, and Protective earth wires.

<sup>2</sup> Unless otherwise noted, twin #10 studs spaced for dual-hole lug with 5/8" hole spacing.

3. Strip the wires to the appropriate length for the lugs to be used.
4. Slip on heat-shrink tubing on the wire ends before assembling the lugs on to the wire.
5. Crimp the lugs with the proper tool, and ensure that the tubing extends over the barrel of the lugs and the insulation on the wires.
6. Use agency-approved compression (pressure) lugs for wiring terminations.
7. Shrink the tubing with a heat gun.

**Figure 12: Lug Preparation**

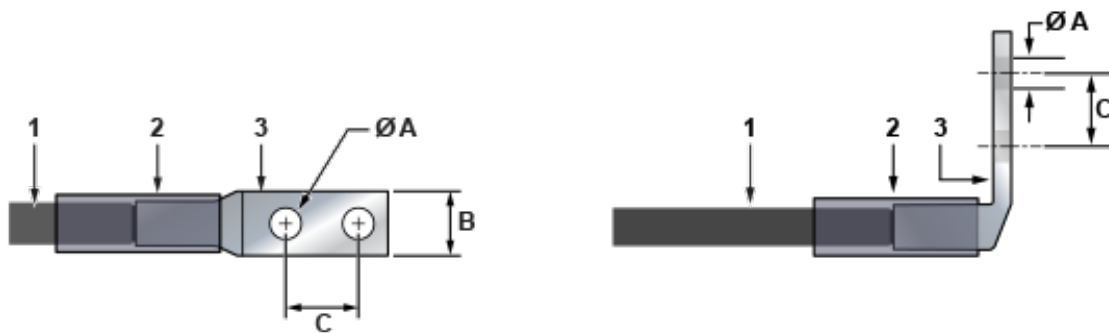

- |                      |        |
|----------------------|--------|
| 1 Insulated wire     | A 1/4" |
| 2 Heat-shrink tubing | B 1/2" |
| 3 Lug                | C 5/8" |



**Note:** Dimension B is the width of the lug (not visible on the right angle lug).

#### 4.2.2 Connecting a DC Power Supply to Power Source

To connect a DC power supply to a power source, perform the following:

1. Prepare the stranded wiring ([Wire and Lug Preparation](#)).
2. Attach the appropriate lugs to the source DC wires.
3. Connect the DC-input wires to the appropriate terminals using the specified torque in the following order.



**Note:** Remove terminal covers as needed.

- a. Ground wire to the Protective Earth (PE) terminal.
  - b. Negative source DC cable to the negative (-48V) terminal.
  - c. Positive (+) source DC cable to the positive (RTN) terminal.
4. Replace the terminal covers as required.



**Note:** The ground (protective earth) terminal is on the opposite side from the other two terminals.





## Connecting Serial and Management Cables

### 5.1 Connecting Supervisor Cables

Supervisor module contains the console, management, and USB ports. The following figure displays port locations on DCS-7388-SUP-D supervisor.

**Figure 13: Supervisor Ports**

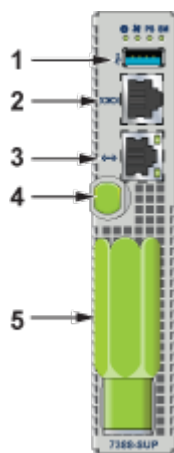

1 USB Port

3 Ethernet Management Port

5 Torque Clutch Tool  
(shared by Supervisor and  
Linecards)

2 Console Port (Serial)

4 Supervisor Release

- Console (Serial) Port: Connect to a PC with RJ-45 to DB-9 serial adapter cable. Default switch settings include:
  - 9600 baud
  - No flow control
  - 1 stop bit
  - No parity bits
  - 8 data bits
- Ethernet management port: Connect to 10/100/1000 management network with RJ-45 cable.

Connect cables as required to line card module ports. Supervisor and line card module ejectors on the front of the chassis assist with cable management.



**Important:**

Excessive bending can damage interface cables, especially optical cables.

Flexion excessive peut endommager les câbles d'interface, en particulier les câbles optiques.

- USB Port: May be used for software or configuration updates.

## 5.2 Connecting Linecard Modules and Cables

Install required QSFP28, QSFP-DD, and OSFP optic modules in linecard module ports.



**Note:** In some devices, adjacent QSFP ports may require you to rotate the module for insertion.

**Figure 14: Optical Module Insertion (representative)**

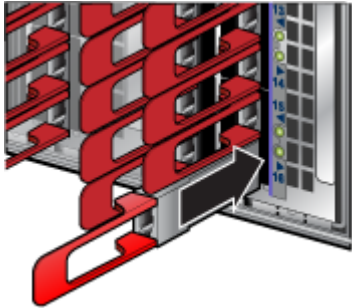

**Note:** For more information about supported optical transceivers, refer to <https://www.arista.com/assets/data/pdf/Transceiver-Guide-V04.pdf>.



**Note:** Excessive bending can damage interface cables, especially optical cables.

## Configuring the Switch

---

Arista switches ship from the factory in Zero Touch Provisioning (ZTP) mode. ZTP configures the switch without user intervention by downloading a startup configuration file or a boot script from a location specified by a DHCP server.

To manually configure a switch, ZTP is bypassed. The initial configuration provides one username (admin) accessible only through the console port because it has no password.

When bypassing ZTP, initial switch access requires logging in as admin, with no password, through the console port. Then you can configure an admin password and other password protected usernames.

This manual configuration procedure cancels ZTP mode, logs into the switch, assigns a password to admin, assigns an IP address to the management port, and defines a default route to a network gateway.

1. Provide power to the switch ([Powering the Modular Switch](#)).
2. Connect the console port to a PC ([Connecting Serial and Management Cables](#)).

As the switch boots without a startup-config file, it displays this message through the console:

```
The device is in Zero Touch Provisioning mode and is attempting to
download the startup-config from a remote system. The device will not
be fully functional until either a valid startup-config is downloaded
from a remote system or Zero Touch Provisioning is cancelled. To
cancel
Zero Touch Provisioning, login as admin and type 'zerotouch cancel'
at the CLI.
localhost login:
```

3. Log into the switch by typing admin at the login prompt.

```
localhost login:admin
```

4. Cancel ZTP mode by typing zerotouch cancel. **IMPORTANT:** This step initiates a switch reboot.

```
localhost>zerotouch cancel
```

5. After the switch boots, log into the switch again by typing admin at the login prompt.

```
Arista EOS
localhost login:admin
Last login: Fri Mar 15 13:17:13 on console
```

6. Enter global configuration mode.

```
localhost>enable
localhost#config
```

7. Assign a password to the admin username with the username secret command.

```
localhost(config)#username admin secret pxq123
```

8. Configure a default route to the network gateway.

```
localhost(config)#ip route 0.0.0.0/0 192.0.2.1
```

9. Assign an IP address (192.0.2.8/24 in this example) to an Ethernet management port.

```
localhost(config)#interface management 1/1
localhost(config-if-Ma1/1)#ip address 192.0.2.8/24
```

10. Save the configuration by typing write memory or copy running-config startup-config.

```
localhost#copy running-config startup-config
```

When the management port IP address is configured, use this command to access the switch from a host, using the address configured in step 9:

```
ssh admin@192.0.2.8
```

Refer to the Arista Networks User Manual for complete switch configuration information.

## Status Indicators

---

### A.1 Supervisor Module Status Indicators

The supervisor displays switch component status and contains Ethernet management and console ports. The supervisor location is on the [Front Panels](#) of the switch.

The supervisor provides one serial console port, one Ethernet management port, and one USB port. Four LEDs on the top edge report system status, fan status, power status, and switch module status. The following figure shows the supervisor module status LEDs.

**Figure 15: Supervisor module status LEDs**

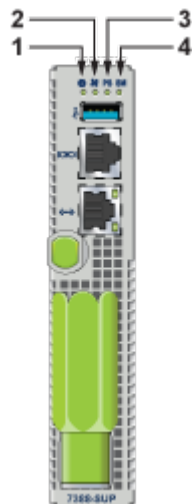

- |                     |                           |
|---------------------|---------------------------|
| 1 System Status LED | 3 Power Supply Status LED |
| 2 Fan Status LED    | 4 Switch Card Status LED  |

#### Supervisor Status LEDs

The following table interprets the states of the LED indicators on the supervisor module. When error conditions are indicated, refer to LEDs on the specified components to determine the condition's source.

**Table 6: Supervisor LED States**

LED Name	LED State	Module State
Power Supply	Green	All powered modules are operating normally.
	Red	At least one module has failed.
System	Green	All linecards are operating normally.
	Red	At least one linecard has failed.
Switch Card	Green	Module is operating normally.
	Red	Module has failed.
Fan	Amber	At least one fan is missing or has failed.
	Green	All modules are operating normally.
	Red	There are insufficient functional fans installed in the switch.

(1): If all Status LEDs are OFF, check the following: power feeds are live, power supplies are installed, Switch Card is properly seated, and Supervisor is properly seated. The system will not power up unless all four of these conditions are valid.

## A.2 Linecard Module Indicators

Each linecard module provides one status LED plus LEDs for each port on the card.

The following figure displays the status LED and port LEDs on the DCS-7388-16CD linecard. Arrows indicate the port status being displayed by the corresponding port status LED.

**Figure 16: Linecard status LEDs (DCS-7388-16CD)**

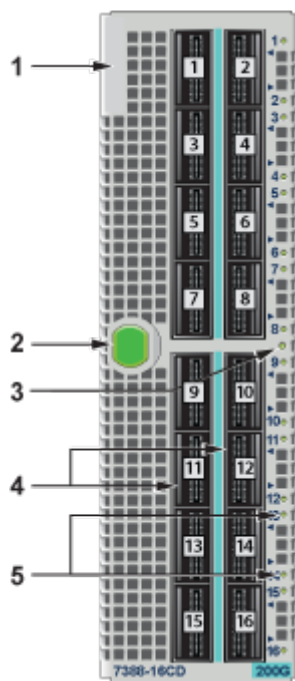

- |  |                       |                    |
|--|-----------------------|--------------------|
| 1 Linecard                             | 3 Linecard Status LED | 5 Port Status LEDs |
| 2 Linecard Ejector<br>(Release) Handle | 4 Linecard Ports      |                    |

The Linecard Status LED is in the center of the DCS-7388-16CD. The following tables interpret the states of the Status LED and the port LED.

**Table 7: Linecard Status LED States**

LED State	Status
Off	Linecard not inserted.
Green	Linecard operating normally.
Yellow (amber/orange)	Linecard administratively shut down.
Red	Linecard has failed.

**Table 8: Linecard Port LED States (SFP, QSFP)**

LED State	Status
Off	Port link is down.
Green	Port link is up.
Yellow (amber/orange)	Port is disabled in software.

**Table 9: Linecard Port LED States (OSFP, QSFP-DD)**

LED State	Status
Off	Port link is down for enabled interfaces.
Green	Port link is up for enabled interfaces and all links are good.
Yellow (amber/orange)	Port is disabled in software for all interfaces or a link is bad.

### A.3 Fan Module Status Indicators

The fan modules are inserted into the switch card module. Each switch contains one switch card and five fan modules accessible from the [Rear Panels](#) of the switch.

The fan module indicator is displayed in the following figure. The fan handle color indicates the airflow direction. All fan modules must have the same color handle.



**Note:** The orientation of the fan module as inserted in the switch may be different from the one shown.

**Figure 17: Fan status LEDs**

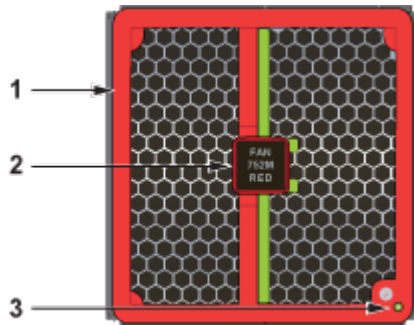

- 1 Fan Airflow Direction Indicator Bezel Color
- 2 Fan Release Handle
- 3 Fan Status LED

The following table interprets the states of the Fan Status LED.

**Table 10: Fan and switch card LED States**

LED State	Status
Off	The module is inserted but not receiving power – it may not be properly seated.
Green	The module is operating normally.
Red	The module has failed.



## A.4 Power Supply Status Indicators

Power Supply LEDs are on power supply modules. The power supply modules for all switches are accessible from the [Rear Panels](#) of the switch.

The following figure displays a power supply module.

The power supply handle indicates the power supply airflow direction. Verify the airflow direction of all fan and power modules. All modules should have the same color handles.

**Figure 18: Power supply**

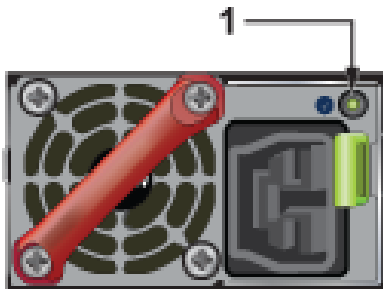

1 Power Supply Status LED

The following table interprets the states of the Power Supply Status LED.

**Table 11: Power Supply Status**

LED	Status
Green	Power Supply module operating normally.
Off	No AC power to the module.
Red	Module has faulted.
Blinking Green	PSU has AC power but hasn't been enabled by the system - indicates that either the power supply or the Switch Module isn't fully inserted.



## Parts List

---

Each switch provides an accessory kit that contains parts required to install the switch into a four-post rack. The following sections list the installation parts provided by the accessory kit.

### B.1 Parts Used in All Configurations

Table 12: Parts Used in All Configurations

Quantity	Description
One for each AC power supply module supplied with switch	Power cables: TBD
One	RJ-45 Patch Panel Cables, 2 meters.
One	RJ-45 to DB9 Adapter Cable, 2 meters.



**Note:** All provided power cables are for use only with Arista products.

#### 警告

すべての電源コードは提供する製品で使用するためだけを目的としている。

#### 電源コードの他の製品での使用の禁止

Aristaが提供するすべての電源コードは、Aristaの製品でのみ使用してください。

### B.2 Four-Post Rack Mount Parts

**Table 13: Four-Post Rack Mount Parts**

Quantity	Description
Two	Mounting Ears
One	Left shelf
One	Right shelf

**Figure 19: Four-Post Rack Mount Parts**

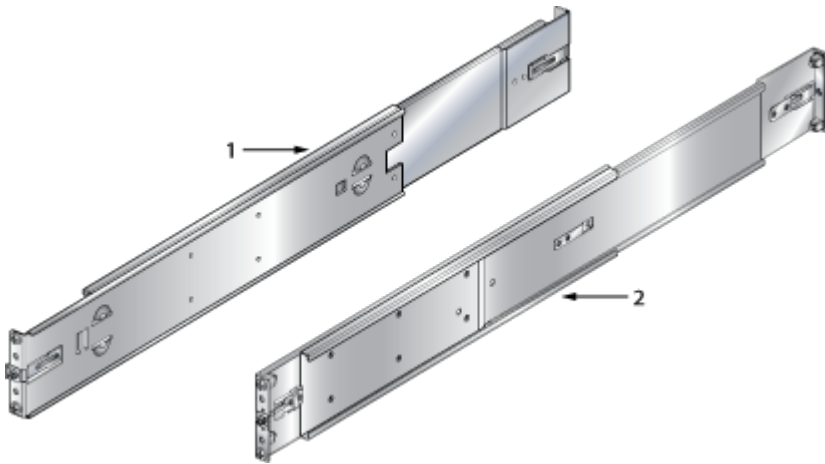

- 1 Left Shelf
- 2 Right Shelf

## Front Panels

The following illustration displays the front panel of all switches covered by this guide.

**Figure 20: DCS-7388X5 Front Panel (fully populated)**

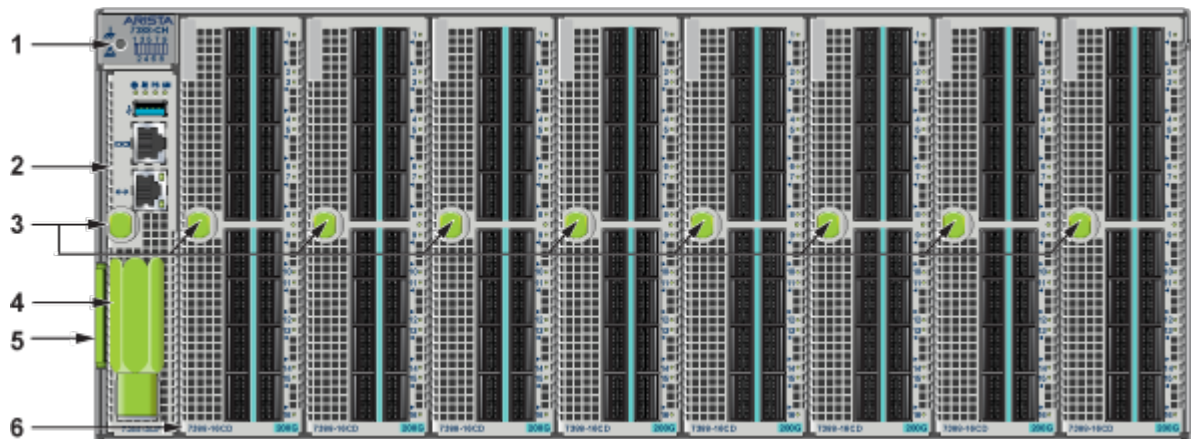

- |                     |   |                                     |
|---------------------|---|-------------------------------------|
| 1 ESD Attach Point  | 3 Supervisor and Linecard Ejector Handle (Release) and Latch Indicator Button | 5 Pull Tag (for Switch Information) |
| 2 Supervisor Module | 4 Supervisor and Linecard Removal Tool  | 6 Linecard                          |



**Note:** Touch points are colored green.



## Rear Panels

The following illustration displays the rear panel of all switches covered by this guide.

**Figure 21: DCS-7388X5 Rear Panel**

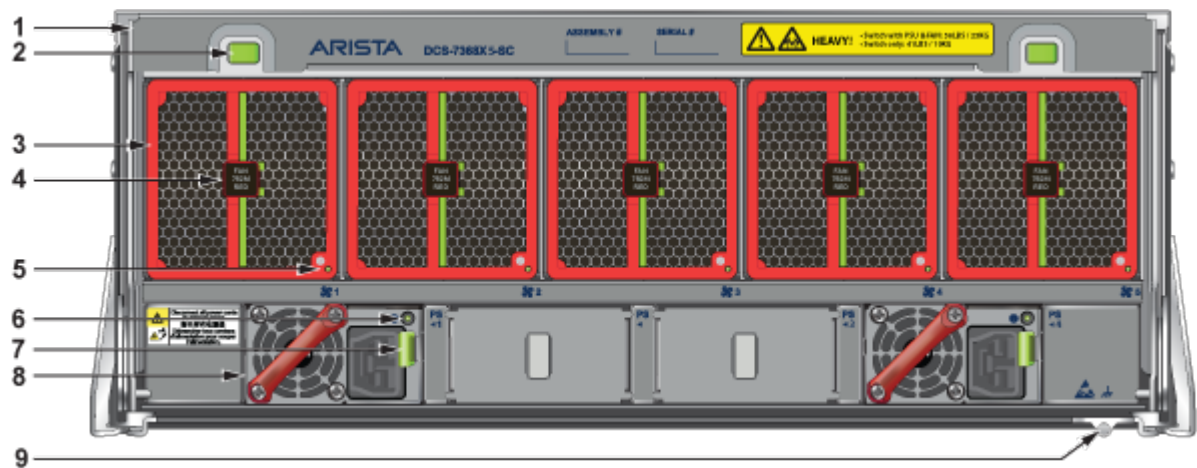

- |                                      |                      |               |
|--------------------------------------|----------------------|---------------|
| 1 Switch Card Module Release Handle  | 4 Fan Module Release | 7 PSU Release |
| 2 Switch Card Module Release Buttons | 5 Fan Status LED     | 8 PSU         |
| 3 Fan                                | 6 PSU Status LED     | 9 Ground      |



**Note:** Touch points are colored green.





# Line Cards

The following illustrations display the Linecards supported by modular switches covered by this guide.

Figure 22: DCS-7388-16CD and DCS-7388-16CD2

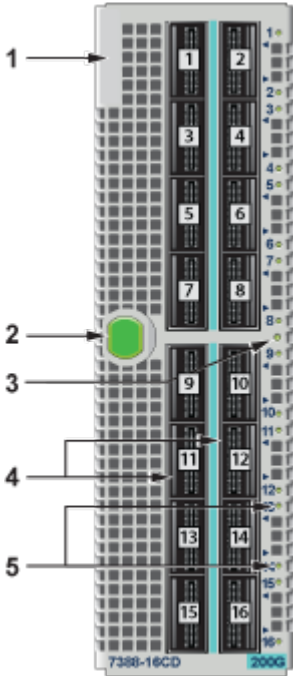

- 1 Linecard
- 2 Linecard Ejector (Release) Handle
- 3 Linecard Status LED
- 4 Linecard Ports
- 5 Port Status LEDs

Figure 23: DCS-7388-8D and DCS-7388-8DR

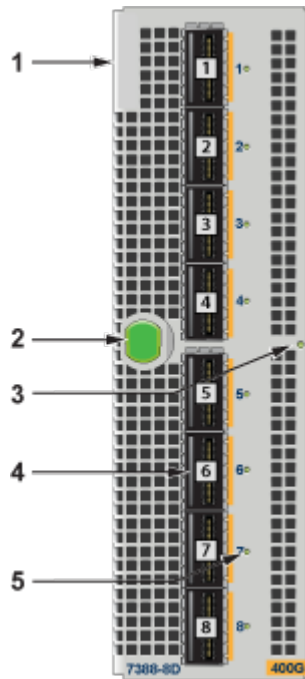

1 Linecard

2 Linecard Ejector  
(Release) Handle

3 Linecard Status LED

4 Linecard Ports

5 Port Status LEDs

## Maintenance and Field Replacement

There is a linecard and supervisor removal tool to facilitate the removal and installation of linecards and supervisor modules. Use the tool as a sleeve on the release handle. It is mounted on the supervisor module [Front Panels](#). Replace the tool after each use.



**Note:** Follow ESD protection protocols while handling components of the switch during maintenance operations.

### F.1 Switch Card Module

The switch card module is accessible from the rear of the switch as shown in [Rear Panels](#). Refer to the following figure for more details on the removal and replacement of the switch card module.

**Figure 24: Switch Card Module Maintenance**



- 1 Switch Card Release Handle (Swing Arm)
- 2 Switch Card Release Buttons

The module includes lock-levers that secure it to the chassis. The module and the lock levers are easily damaged by improperly removing, inserting, or handling. Use caution while lifting or moving the module after it is removed from the chassis.

#### F.1.1 Removing Switch Card Module

The switch card module can include the fans and the power supplies. The release handle is a swing arm that is used for unseating and seating the switch card module.

Follow the steps listed below to remove the switch card module from the switch chassis.

1. Ground yourself with an ESD wrist strap.
2. Push the switch card release buttons.
3. Move the release handle (swing arm) down.
4. Carefully, remove the switch card module from the chassis while supporting it through the process.

#### F.1.2 Inserting Switch Card Module

The module insertion process is the inverse of the removal procedure. Follow the steps listed below to insert the switch card module into a chassis.

1. Align the switch card module with the rails in the chassis for insertion.
2. Lower the release handle (swing arm) down. Slide the module until it stops.



**Note:** The module will stop about 8 mm (1/3") from the back of the switch.

3. Close the release handle (swing arm) to its locked position (up) until both the green buttons pop out.



**Note:** The upward swing arm movement will push and seat the switch card module. The green buttons pop out to indicate that the switch card module is locked. When locked, the release handle will not move down.

## F.2 Power Supplies

The power supplies are accessible from the rear of the switch ([Rear Panels](#)). Refer to the following figure for more details on the removal and replacement of a power supply unit.



**Note:** Descriptions for the removal and replacement of power supplies and fans are for a representative power supply or fan. Locations of status indicator LEDs may differ. Refer to the front and rear panel illustrations of your device to locate the appropriate LED.

The following steps are required when removing power supplies from a switch.

### F.2.1 Removing a Power Supply

1. Ground yourself with an ESD wrist strap.
2. Power down the power supply to be removed by disconnecting the AC power cable.
3. Push the power supply release handle and remove the power supply as shown in the figure below.

**Figure 25: Remove power supply**

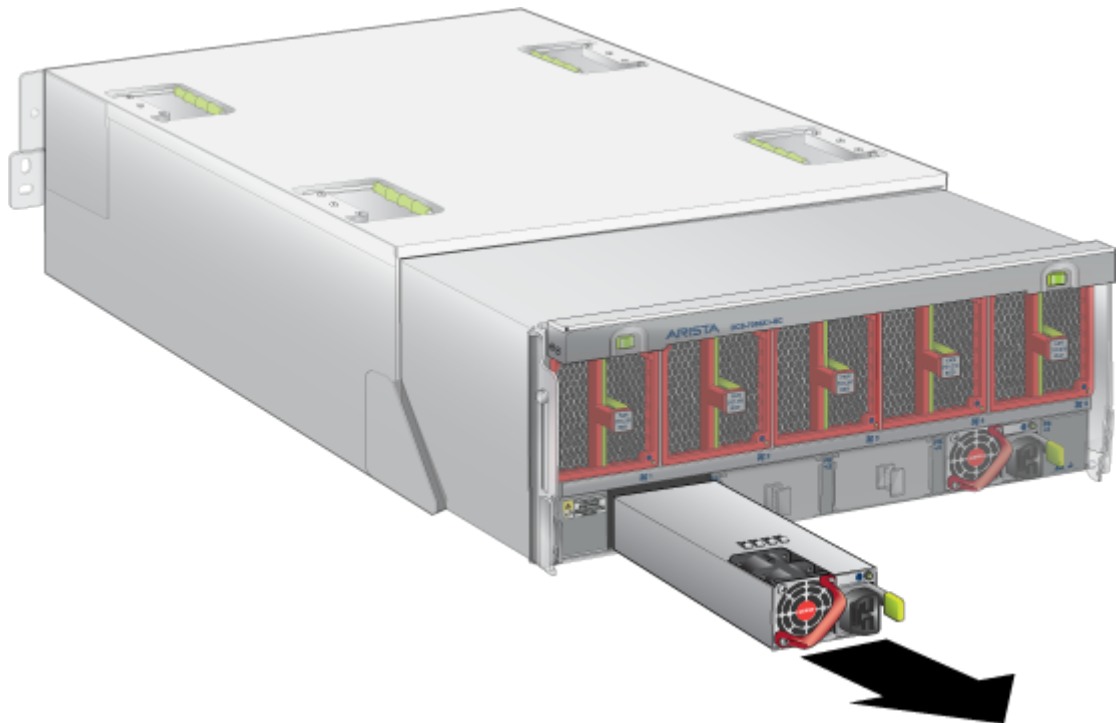

**Note:** PSUs are hot swappable and do not require the removal of the switchcard. The illustration shows the switchcard removed for clarity.

## F.2.2 Installing a Power Supply

You must make space for installing the power supply by removing an existing one ([Removing a Power Supply](#)).

1. Remove the replacement power supply from its packaging.
2. Slide the new power supply into the empty slot.
3. Slide the new power supply into the switch until the power supply is fully seated and the release handle snaps into place.
4. Connect the power cord to the power supply.
5. Verify the LED(s) on the power supply. Note The Power Supply status LED should be a steady green for normal operation.



**Note:** The Power Supply status LED should be a steady green for normal operation.

6. Verify the new power supply operation by issuing the show environment power command.

```
switch#show environment power
```

The output of the command will list the power supplies in operation and should include the one you replaced.

## F.3 Fan Modules

The fan modules are accessible from the rear of the switch as shown in [Rear Panels](#). Refer to the following figure for more details on the removal and replacement of a fan module.

### F.3.1 Removing a Fan Module

The following steps are required when removing or replacing fans from a switch.





**Note:** A representative fan is shown for the task. For the fan on your device refer to [Fan Module Status Indicators](#) for the location of the release.

1. Ground yourself with an ESD wrist strap.

2. Pinch the fan module release lever and slide the fan module out of the switch as shown in the figure below.

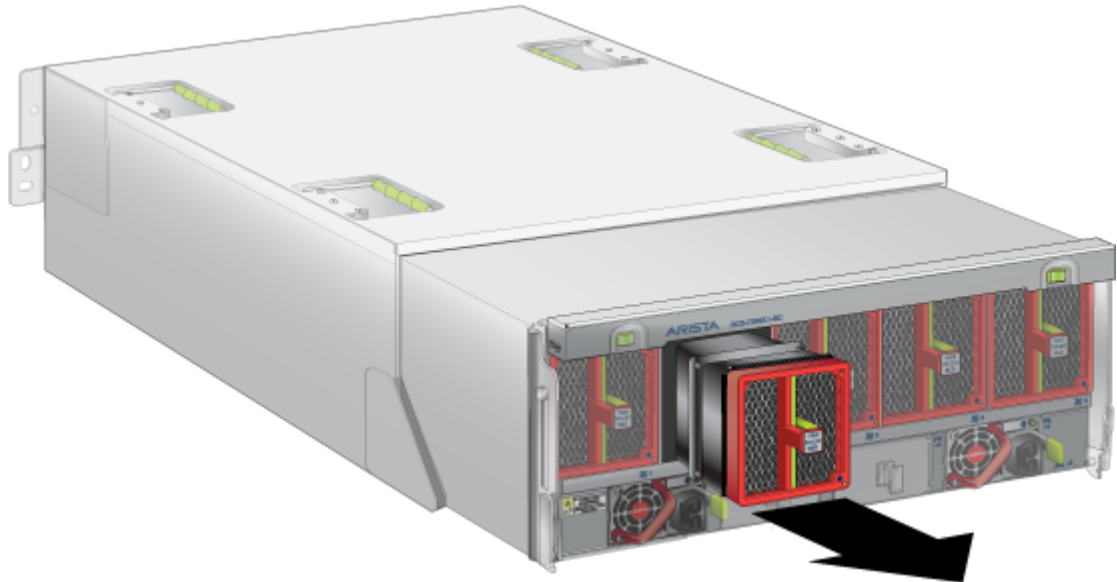
**Figure 26: Removing fan module**



 **Note:** Fans are hot swappable and do not require the removal of the switchcard. The illustration shows the switchcard removed for clarity.

### F.3.2 Installing a Fan Module

You must make space for installing the fan module by removing an existing one ([Removing a Fan Module](#)).

1. Remove the replacement fan from its packaging.
2. Slide the new fan module into the switch until the module is fully seated and the release lever snaps into place. The fan installation indicator will be green when the fan is installed and seated correctly.
3. Verify that the fan module is working normally.

 **Note:** The fan module status LED should be a steady green for normal operation. The LED is amber when a wrong fan is installed.

## F.4 Supervisor Module

The supervisor module is accessible from the front of the switch as shown in [Front Panels](#). Refer to the following figure for more details on the removal and replacement of a supervisor module.

 **Note:** Supervisors are hot-swappable. The switch will reboot when the replacement supervisor powers up.

### F.4.1 Removing Supervisor Module

The supervisor module has a release handle with a push button latch indicator. The ejector tool works for both the linecards and the supervisor.

Perform the following steps to remove the module.

1. Put on a grounded ESD strap.
2. Remove the linecard and supervisor removal tool from the front of the switch [Front Panels](#).

3. Push in the latch indicator button.



**Note:** The handle will rotate freely without loosening the supervisor module if the latch indicator button is not pushed in.

4. Attach the removal tool to the supervisor module ejector handle.
5. Use the tool to rotate the ejector handle counterclockwise to release the supervisor module.
6. Gently remove the supervisor module by pulling outwards once the tool rotation stops moving the supervisor module outwards (approximately five turns).



## F.4.2 Installing Supervisor Module

You must make space for installing the module by removing an existing one ([Removing Supervisor Module](#)). Perform the following steps to install the module.

1. Put on a grounded, anti-static ESD strap.
2. Unpack the supervisor module to be installed.
3. Slide supervisor module into slot.
4. Push the latch indicator button in.
5. Use the removal tool to rotate the ejector handle clockwise until the tool rotates freely.
6. Remove the tool to see if the latch indicator button has popped out.



**Note:** The latch indicator button pops out and the tool rotates freely when the supervisor is fully seated.



**Note:** Hand tightening is sufficient for installation.

## F.5 Linecards

The linecards are accessible from the front of the switch as shown in [Front Panels](#). The linecards are hot-swappable. You must take into account that the linecard you are inserting is compatible with the switch and the linecard that you are replacing. Refer to the following figure for more details on the removal and replacement of a linecard module.



**Note:** A representative linecard is shown for illustration.

**Figure 27: Linecard Module Maintenance**

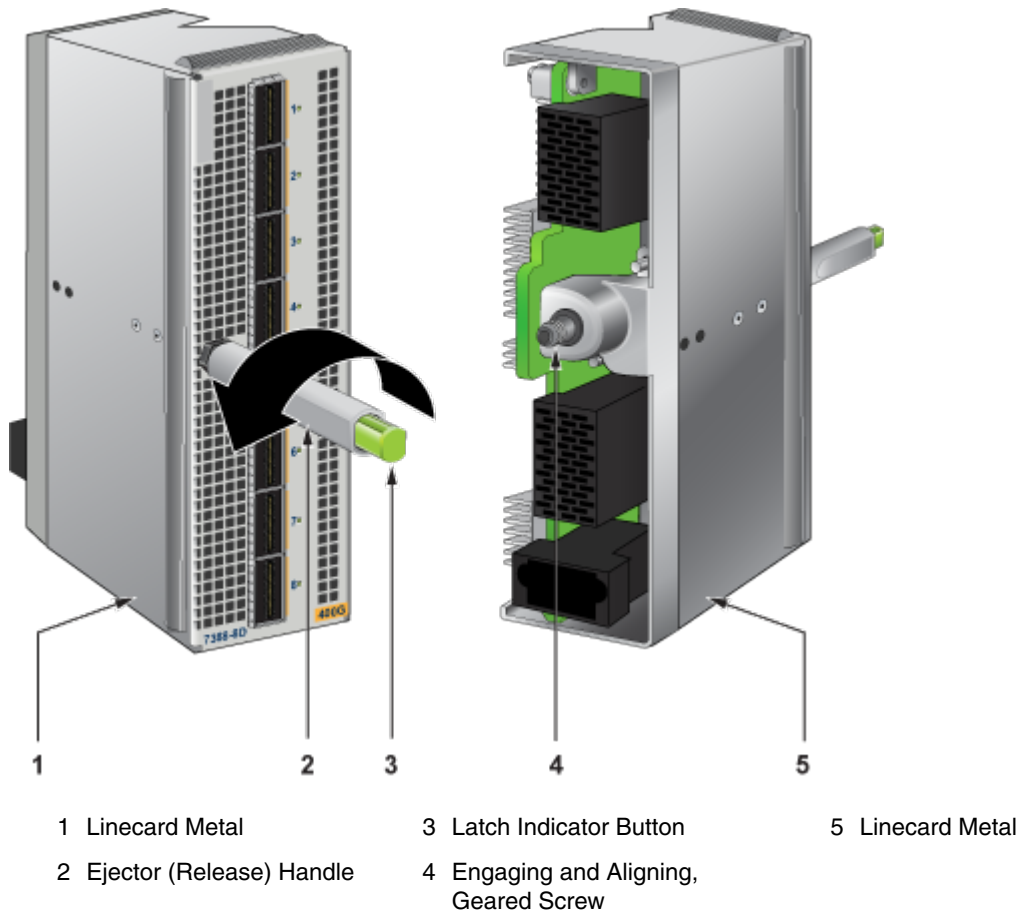

### F.5.1 Removing Linecard

Perform the following steps to remove a linecard.

1. Put on a grounded ESD strap.
2. Remove the linecard (and supervisor) removal tool from the front of the switch [Front Panels](#).
3. Push in the latch indicator button on the linecard to be removed.



**Note:** The handle will rotate freely without loosening the linecard if the latch indicator button is not pushed in.

4. Attach the tool to the linecard ejector handle.
5. Use the tool to rotate the handle counterclockwise to release the linecard.
6. Gently remove the linecard by pulling outwards.





## F.5.2 Installing Linecard

You must make space for installing the linecard by removing an existing one ([Removing Linecard](#)) from a linecard slot available on the switch.

1. Put on a grounded, anti-static ESD strap.
2. Unpack the linecard to be installed.
3. Slide the linecard gently into the slot.
4. Push the latch indicator button in.
5. Use the removal tool to rotate the ejector handle clockwise until the tool rotates freely.
6. Remove the tool to see if the latch indicator button has popped out.



**Note:** The latch indicator button pops out and the tool rotates freely when the linecard is fully seated.



**Note:** Hand tightening is sufficient for installation.

7. Verify that the linecard is operating normally ([Linecard Module Indicators](#)).

## F.6 Optical Transceivers

For more information about supported optical transceivers and how to remove or install them, refer to <https://www.arista.com/assets/data/pdf/Transceiver-Guide-V04.pdf>.



## Regulatory Model Numbers

---

The following table lists the regulatory model numbers (RMNs), where applicable, for the product models for the switches described in this document.

**Table 14: Regulatory Model Numbers and Product Numbers**

Regulatory Model Number (RMN)	Product Number(s)
DCS-7388	DCS-7388X5



### Taiwan RoHS Information

---

The following link provides Taiwan RoHS information for switches covered by this guide. For Taiwan BSMI RoHS Table, go to <https://www.arista.com/assets/data/pdf/AristaBSMIRoHS.pdf>.

